



## Product Catalogue

Version 5.1 | [armorgard.co.uk](http://armorgard.co.uk)



 **armorgard**  
tuffbank™

MANITOU



# Welcome

**to the latest edition of the Armorgard product catalogue.** This catalogue includes our extensive range of market-leading solutions for on-site security, safety and productivity. All of our products are exclusive to Armorgard and come from the work of our talented in-house R&D team. Our latest innovations are used as essential solutions for H&S best practices. You won't find the same products anywhere else, and you certainly won't find better.

For help, advice and to place orders, contact our team on **023 9238 0280** or email **[sales@armorgard.co.uk](mailto:sales@armorgard.co.uk)**  
**[armorgard.co.uk](http://armorgard.co.uk)**



The images used throughout are for the purpose of illustration and reference only. Content may not be included as standard. Please note that dimensions are approximate.





# What we stand for...



## Our vision

To supply and produce innovative solutions to increase safety and productivity in workplaces all over the world.



## Our mission

Design and manufacture market-leading products for secure tool storage, efficient manual handling and improved site safety.



## Our values (SHAPE)

### Supportive

- We treat our colleagues and our customers with respect
- We work as a team to ensure success



### Honest

- We are clear in all communication, providing assurance to our customers and colleagues
- We build trust with all of our customers and colleagues through managing expectations



### Accountable

- We do what we say we will do
- We are accountable as a team and as individuals



### Passionate

- We strive to be positive role models, demonstrating passion for our business
- We are inquisitive and open to new ideas



### Excellence

- We aim to exceed expectations through our performance
- We always aim higher for our customers



» Robust » Secure » Trusted



# We look at things from a different angle

Every product is developed in response to a need. We listen to all customers and create the perfect solutions to their problems.

Our team continue to develop excellent new products that are tough, dependable and purpose-built for your needs. Plus, we won't keep you waiting. We pride ourselves on our high stock levels and next-day delivery on all stock items.

If you have an idea for a new product or feedback on an existing one, we'd love to hear from you. Please send an email to [marketing@armorgard.co.uk](mailto:marketing@armorgard.co.uk)



**Next-day delivery on stock items ordered before 3pm**



**Replacement keys & parts available. See page 118**



**“Our product team is continually developing new ideas – tough, dependable products.”**

---

# Contents

<b>SECTION 01</b>	strongbank™ ..... 10	tuffstor cabinet™ ..... 26
<b>Tool and equipment storage</b>	tuffbank™ ..... 12	fittingstor™ ..... 28
	oxbox™ ..... 16	pipestor™ ..... 32
	trekdror™ ..... 18	tuffcrate™ ..... 33
	barrobox™ ..... 22	forma-stor™ ..... 34
	toolbin™ ..... 24	strimmersafe vault™ ..... 38
	powerstation™ ..... 25	strimmersafe rack™ ..... 39
<b>SECTION 02</b>	instagate™ ..... 42	cuttingstation™ ..... 48
<b>Work platforms and units</b>	barricade™ ..... 44	sitestation™ ..... 52
	tuffbench™ ..... 45	cuttingcube™ ..... 54
	mobile tuffbench™ ..... 46	
<b>SECTION 03</b>	scrubkart™ ..... 58	
<b>Welfare products</b>	forma-shelta™ ..... 59	
	sanistation mini™ ..... 60	
	sanistation™ ..... 61	
<b>SECTION 04</b>	piprack™ ..... 64	v-kart™ ..... 80
<b>Manual handling products</b>	ductrack™ ..... 68	beamkart™ ..... 80
	bundlerack™ ..... 70	turntable truck™ ..... 81
	loadall™ ..... 71	t-kart™ ..... 82
	rubble truck™ ..... 76	spoolkart™ ..... 84
	flexikart™ ..... 78	
<b>SECTION 05</b>	A guide to storing hazardous substances ..... 88	safestor™ ..... 102
<b>Hazardous goods storage</b>	flambank™ ..... 90	forma-stor COSHH™ ..... 104
	flamstor cabinet™ ..... 94	flamstor™ ..... 108
	transbank™ ..... 96	tuffcage™ ..... 110
	transbank chem™ ..... 98	drumcage™ ..... 111
	chembank™ ..... 100	gorilla gas cage™ ..... 112
	chemcube cabinet™ ..... 101	drumbank™ ..... 114
<b>SECTION 06</b>	Replacement keys and parts ..... 118	



## SECTION 01 TOOL AND EQUIPMENT STORAGE







---

## SECTION 01

### Tool and equipment storage

strongbank™	10
tuffbank™	12
oxbox™	16
trekdror™	18
barrobox™	22
toolbin™	24
powerstation™	25
tuffstor cabinet™	26
fittingstor™	28
pipestor™	32
tuffcrate™	33
forma-stor™	34
strimmersafe vault™	38
strimmersafe rack™	39

The ultra-strong range of tool safes

StrongBank™ – the world's toughest strongbox. When we started out, our goal was to design and build the ultimate secure storage box. The result was StrongBank™. Now, more than 30 years later, there is still nothing on the market that compares.

This state-of-the-art strongbox delivers virtually indestructible performance to deter even the most determined thief.

 armorgard

# strongbank™



**REINFORCED LID**  
INCLUDING CORNER  
BRACE FOR EXTRA  
SECURITY



**KEYED ALIKE 5-LEVER**  
DEADLOCKS BOTH SIDES  
WITH HEAVY-DUTY  
CHUBB-STYLE KEYS

**UNIQUE EXTERNAL**  
AND INTERNAL ANTI-JEMMY  
SYSTEMS AND FULLY  
WELDED CONTINUOUS  
PIANO HINGE

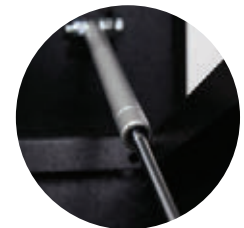

**STRONG GAS STRUTS**  
AND SLAMSTOP LID STAY  
FITTED AS STANDARD  
- CONFORMS TO  
INDUSTRY STANDARDS

**POWDER-COATED**  
FOR MAXIMUM DURABILITY

FORK SKIDS  
WITH FIXING SLOTS FOR  
EASILY ADDING CASTORS  
(EXCEPT SB1)

**ROBUST**  
CONSTRUCTION  
FROM 2 & 3 MM  
HEAVY-DUTY STEEL  
PLATE WITH 5 MM  
REINFORCEMENTS

**SUITABLE FOR VANS,  
TRUCKS, WORKSHOPS  
AND SITES**



For on-site solutions, call our customer experience team on **023 9238 0280** or email **sales@armorgard.co.uk**

» "IT IS QUITE SIMPLY WITHOUT RIVAL."

» OPTIONAL EXTRAS



HEAVY-DUTY CASTORS  
USING THE PRE-DRILLED  
HOLES (EXCEPT SB1)



SB1



SB2



SB3



SB6

480 MM



SB1

665 MM



SB2

970 MM



SB3

665 MM



SB6

Product Code	Description	Weight (kg)	External Dimensions W x D x H (mm)	Internal Dimensions W x D x H (mm)
SB1	Van Box	59	1030 x 565 x 480	895 x 460 x 470
SB2	Site Box	98	1310 x 690 x 665	1185 x 605 x 575
SB3	Site Box	120	1300 x 690 x 970	1185 x 600 x 880
SB6	Truck Box	138	2000 x 690 x 665	1885 x 605 x 580

Note: Weights and dimensions are approximate. External dimensions include handles.

**Our best-selling  
secure site  
storage solution**

Built to a rigorous specification with a host of innovative features, **TuffBank™** sets the industry benchmark for quality and functionality. A Sold Secure and Secured by Design accredited product, its heavy-duty steel plate construction and unique anti-jemmy technology means that it is virtually impregnable.

# **armorgard** **tuffbank™**

TB2



## » OPTIONAL EXTRAS

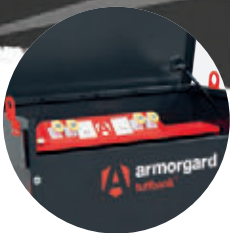

**UNIQUE POWERSHELF**  
SECURELY CHARGES TOOLS  
AND MOBILE DEVICES



**LIFTING EYES**  
TO ALLOW FOR  
TRANSIT BY CRANE



**HEAVY-DUTY CASTORS**  
INCREASE MOBILITY  
ON-SITE



TURN OVER FOR MORE INFORMATION ABOUT THE TUFFBANK™

INSET HANDLES FOR A MORE STREAMLINED PRODUCT REQUIRING LESS SPACE

OPTIONAL SHELVES FOR CONVENIENT STORAGE OF SMALLER ITEMS

ROBUST CONSTRUCTION FROM HEAVY-DUTY STEEL PLATE THROUGHOUT

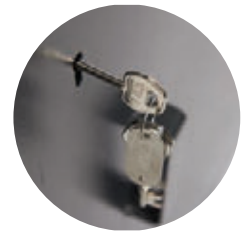

KEYED ALIKE 5-LEVER DEADLOCKS BOTH SIDES WITH HEAVY-DUTY CHUBB-STYLE KEYS



CABLE PASSING POINT TO ALLOW CHARGING WITHOUT COMPROMISING SECURITY

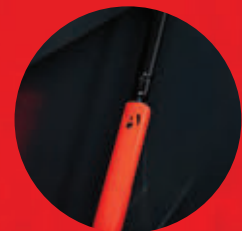

STRONG GAS STRUTS AND SLAMSTOP LID STAY FITTED AS STANDARD - CONFORMS TO INDUSTRY STANDARDS



UNIQUE EXTERNAL AND INTERNAL ANTI-JEMMY SYSTEMS AND FULLY-WELDED CONTINUOUS PIANO HINGE



TBC4

FORKSKIDS WITH FIXING SLOTS FOR EASILY ADDING CASTORS (EXCEPT TB1 AND TB12)

FULL RANGE IS SUITABLE FOR VANS, TRUCKS, WORKSHOPS AND SITES

POWDER-COATED FOR MAXIMUM DURABILITY

TOOL AND EQUIPMENT STORAGE



» WATCH THE TUFFBANK™ IN ACTION

» MARKET-LEADING TOOL VAULT  
OFFERING BEST-IN-CLASS  
PERFORMANCE

# armorgard tuffbank™



TB1



TB2



TB21



TB3





Product Code	Description	Weight (kg)	External Dimensions W x D x H (mm)	Internal Dimensions W x D x H (mm)
TB1	Van Box	50	950 x 505 x 460	920 x 470 x 450
TB12	Truck Box	58	1150 x 495 x 460	1120 x 470 x 450
TB21	Site Box	60	760 x 615 x 640	730 x 590 x 540
TB2	Site Box	80	1150 x 615 x 640	1120 x 590 x 540
TB3	Site Box	97	1150 x 615 x 930	1120 x 590 x 840
TBC4	Site Chest	127	1150 x 615 x 1265	1120 x 590 x 1175
TBC5	Site Chest	153	1525 x 615 x 1265	1495 x 590 x 1175
TB6	Truck Box	119	1925 x 615 x 640	1895 x 590 x 540
CLEK	Lifting Eye Kit	2	N/A	N/A
TBFK	TuffBank™ Fixing Kit	0.5	N/A	N/A
SHE-4	TuffBank™ Shelf	3	1100 x 150 x 95	1095 x 145 x 25
SHE-D4	TuffBank™ Deep Shelf	4	1100 x 250 x 95	1095 x 245 x 25
SHE-D5	TuffBank™ Deep Shelf	6	1460 x 250 x 95	1455 x 245 x 25
SHE-P4-110	TuffBank™ PowerShelf	6	1100 x 150 x 95	1095 x 145 x 25
SHE-DP4-110	TuffBank™ Deep PowerShelf	6	1100 x 250 x 95	1095 x 245 x 25
SHE-DP5-110	TuffBank™ Deep PowerShelf	8	1460 x 250 x 95	1455 x 245 x 25

\*Optional shelves available for on-site chests; see page 119. Note: Weights and dimensions are approximate. External dimensions include handles.

The robust, good value solution for securing tools and equipment

OxBox™ tool vaults provide a fantastic combination of security and affordability. OxBox™ shares many of the premium features of our higher-priced storage box ranges, including locks, hinges, gas struts and paint finish. Its unique "folded" construction delivers outstanding strength. The OxBox™ is available in 6 sizes and is made from 1.5 mm and 2 mm steel.

# armorgard oxbox™

STEEL PLATE CONSTRUCTION WITH DURABLE POWDER-COATED FINISH



KEYED ALIKE 5-LEVER DEADLOCKS BOTH SIDES WITH HEAVY-DUTY CHUBB-STYLE KEYS

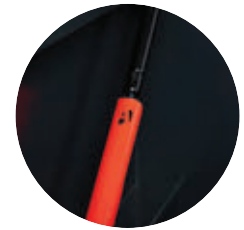

STRONG GAS STRUTS FITTED AS STANDARD - CONFORMS TO INDUSTRY STANDARDS

SUITABLE FOR VANS, TRUCKS, WORKSHOPS AND SITES

»» OPTIONAL EXTRAS



HEAVY-DUTY CASTORS USING THE PRE-DRILLED HOLES (EXCEPT OX05, OX1, OX2 AND OX6)



OX3

FORK SKIDS WITH FIXING SLOTS FOR EASILY ADDING CASTORS (EXCEPT OX1, OX2 AND OX6)



For on-site solutions, call our customer experience team on **023 9238 0280** or email [sales@armorgard.co.uk](mailto:sales@armorgard.co.uk)



» "EFFECTIVE SECURITY - GREAT VALUE"



Product Code	Description	Weight (kg)	External Dimensions W x D x H (mm)	Internal Dimensions W x D x H (mm)
OX05	Van Box	27	810 x 470 x 385	755 x 425 x 370
OX1	Van Box	32	885 x 470 x 450	830 x 425 x 435
OX2	Truck Box	41	1155 x 450 x 460	1130 x 425 x 445
OX3	Site Box	60	1210 x 625 x 645	1115 x 595 x 550
OX4	Site Chest	89	1215 x 595 x 1185	1125 x 570 x 1090
OX6	Truck Box	60	1740 x 515 x 445	1715 x 485 x 430

\*Optional shelves available for on-site chests; see page 119. Note: Weights and dimensions are approximate. External dimensions include handles.



**Our range of robust steel tool drawers for vehicles and small spaces**

TrekDror™ offers ultimate versatility to keep everything tidy and organised in your vehicle, from your power tools right down to that 5 mm screwdriver. TrekDror™ units are designed to fit neatly into smaller spaces and can be fixed down. Each TrekDror™ is cased in corrugated steel with reinforced ribs and 5-lever deadlocks to give you that extra layer of security.

# armorgard trekdror™



» WATCH THE TREKDROR™ IN ACTION

ROBUST CORRUGATED 1.5 MM STEEL CASING PROVIDES DURABILITY AND STRENGTH

TKD1 AND TKD3 CAN BE STACKED

ACCESS CONTENT EASILY AND SAFELY

AVAILABLE IN 3 DIFFERENT SIZES

DRAWER EXTENDS OUT OVER 80% FOR SPACE EFFICIENCY

TKD1

TKD3



UNIQUE ROLLER SYSTEM ENSURES A SMOOTH OPERATION

KEYED ALIKE 5-LEVER DEADLOCKS FOR MAXIMUM SECURITY

RECESSED HANDLES

TOOL AND EQUIPMENT STORAGE



For on-site solutions, call our customer experience team on **023 9238 0280** or email **sales@armorgard.co.uk**

» "BRILLIANT! AMAZING TO SEE HOW MUCH KIT YOU CAN FIT IN THEM"

# armorgard trekdror™

TKD1



TKD2



TKD3



»  
OPTIONAL EXTRAS



MOUNTING KIT ALLOWS THE TREKDROR™ TO BE MOUNTED



DIVIDER KIT ALLOWS YOU TO EASILY ORGANISE YOUR TOOLS



OPTIONAL ANTI-SLIP RUBBER MAT TO PREVENT TOOLS FROM MOVING



STACKING KIT ALLOWS THE TREKDROR™ TO BE STACKED

Product Code	Description	Weight (kg)	External Dimensions W x D x H (mm)	External Dimensions 2 (Including Drawer Open) W x D x H (mm)	Internal Dimensions W x D x H (mm)
TKD1	TrekDror™	44	490 x 1105 x 300	490 x 1900 x 300	405 x 1040 x 245
TKD2	TrekDror™	63	980 x 1105 x 200	980 x 1905 x 200	900 x 1040 x 145
TKD3	TrekDror™	58	490 x 1105 x 490	490 x 1905 x 490	405 x 1040 x 435
TKD1D	TrekDror™ Divider Kit	3	435 x 3 x 240	N/A	N/A
TKD2D	TrekDror™ Divider Kit	3	925 x 3 x 110	N/A	N/A
TKD3D	TrekDror™ Divider Kit	3	435 x 3 x 400	N/A	N/A
TKDMPK	TrekDror™ Mounting Kit	1	N/A	N/A	N/A
TKDSPK	TrekDror™ Stacking Kit	1	N/A	N/A	N/A
TKD1RM	TrekDror™ Mat for TKD1	1.5	437 x 1040 x 3	N/A	N/A
TKD2RM	TrekDror™ Mat for TKD2	3	927 x 1040 x 3	N/A	N/A
TKD3RM	TrekDror™ Mat for TKD3	1.5	437 x 1040 x 3	N/A	N/A

Note: Weights and dimensions are approximate. External dimensions include handles.

The ultimate portable tool protection for tradesmen on the move

BarroBox™ is secure, robust, and extremely versatile. This one-of-a-kind, mobile site box protects your tools wherever you need to work.

Easily wheel tools and equipment around on-site, then use a lever from inside the box to raise the wheels and lock to create a static, secure tool vault.

# armorgard barrobox™



KEYED ALIKE 5-LEVER DEADLOCKS BOTH SIDES WITH HEAVY-DUTY CHUBB-STYLE KEYS

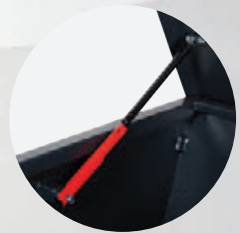

STRONG GAS STRUTS FITTED AS STANDARD - CONFORMS TO INDUSTRY STANDARDS

SLAMSTOP LID STAY FOR ADDITIONAL USER SAFETY

ANTI-JEMMY FEATURES FOR INCREASED SECURITY



LIFTING HANDLE INSTANTLY CONVERTS BARROBOX™ FROM MOBILE TO STATIC

ROBUST FOLDING HANDLES ENSURE THE BARROBOX™ IS EASY TO MANOEUVRE

ROBUST CONSTRUCTION FROM HEAVY-DUTY STEEL PLATE THROUGHOUT

POWDER-COATED FOR MAXIMUM DURABILITY

HEAVY-DUTY WHEELS TO TAKE IMPACT



For on-site solutions, call our customer experience team on **023 9238 0280** or email **sales@armorgard.co.uk**



» WATCH THE  
BARROBOX™  
IN ACTION



TOOL AND EQUIPMENT STORAGE

Product Code	Description	Weight (kg)	External Dimensions W x D x H (mm)	Internal Dimensions W x D x H (mm)
BB2	BarroBox™	82	770 x 1045 x 716	600 x 797 x 608

Note: Weights and dimensions are approximate. External dimensions include handles.

The lightweight vault for storing everyday tools and materials

Manufactured from galvanised steel, this lightweight vault is designed to store less valuable items in locations where high security is not a priority. Versatile and cost-effective, ToolBin™ protects your tools and materials from the elements while keeping them safe from opportunists.

# armorgard toolbin™



IDEAL FOR SECURING LESS VALUABLE ITEMS AND KEEPING BUILDING MATERIALS CLEAN AND DRY

LOCKABLE WITH 2 X HASP AND STAPLES

GALVANISED STEEL CONSTRUCTION

WEATHERPROOF DESIGN TO KEEP YOUR TOOLS PROTECTED

GB3

STRENGTHENERS ON ALL FOUR CORNERS

DOUBLE RETURN ALONG THE BOTTOM EDGE TO STRENGTHEN THE BASE



For on-site solutions, call our customer experience team on **023 9238 0280** or email [sales@armorgard.co.uk](mailto:sales@armorgard.co.uk)

Product Code	Description	Weight (kg)	External Dimensions W x D x H (mm)	Internal Dimensions W x D x H (mm)
GB3	ToolBin™	23	1190 x 585 x 850	1150 x 555 x 825

Note: Weights and dimensions are approximate. External dimensions include handles.



The secure powered locker for safe, segregated battery charging

Power tools and mobile devices are especially vulnerable to theft when being charged on-site. **PowerStation™** gives you the confidence that your unattended equipment is secure and safe from thieves. Each individual locker includes a double socket. Replacement keys can be provided for each individual lock.



# powerstation™



10 SEPARATE COMPARTMENTS WITH INDIVIDUAL LOCKS



DOUBLE SOCKET IN EACH COMPARTMENT. USB SOCKETS ARE ALSO AVAILABLE

PWS10

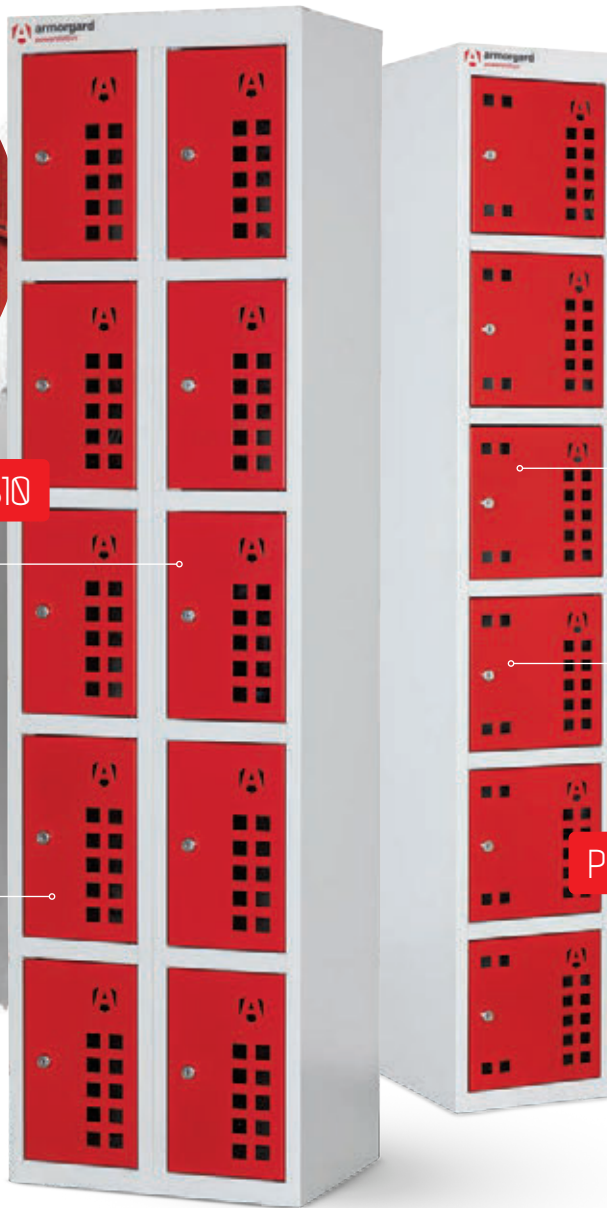

230 V RCD PROTECTED PLUG

PERFORATED DOORS FOR VENTILATION AND VISIBILITY

ALL STEEL CONSTRUCTION

PWS6



» WATCH THE POWERSTATION™ IN ACTION

TOOL AND EQUIPMENT STORAGE

Product Code	Description	Weight (kg)	External Dimensions W x D x H (mm)	Internal Dimensions W x D x H (mm)
PWS6	PowerStation™	28	300 x 460 x 1715	Single Locker: 300 x 385 x 315
PWS10	PowerStation™	40	455 x 365 x 1705	Single Locker: 225 x 290 x 350

Note: Weights and dimensions are approximate. External dimensions include handles. Optional extras - replacement keys, replacement locks.

The ultra-tough cabinet that keeps your equipment organised and accessible

TuffStor Cabinet™ offers the same level of security as a conventional site safe but uses less floor space. This versatile, secure cabinet keeps tools safe and easily accessible. Ideal for use in workshops and vehicles. Want it mobile? It's easy to add castors using the pre-drilled holes.

 **armorgard**

# tuffstor cabinet™



TSC3



KEYED ALIKE 5-LEVER DEADLOCKS BOTH SIDES WITH HEAVY-DUTY CHUBB-STYLE KEYS

FULLY ADJUSTABLE SHELVES FITTED ON ALL SIZES

POWDER-COATED FOR MAXIMUM DURABILITY

HEAVY-DUTY DOORS WITH FIXED HINGES AND CONCEALED ANTI-JEMMY SYSTEM

ROBUST CONSTRUCTION FOR MAXIMUM PROTECTION

FORK SKIDS WITH FIXING SLOTS FOR EASILY ADDING CASTORS



For on-site solutions, call our customer experience team on **023 9238 0280** or email [sales@armorgard.co.uk](mailto:sales@armorgard.co.uk)



»  
OPTIONAL EXTRAS



HEAVY-DUTY CASTORS  
USING THE PRE-DRILLED  
HOLES



TOOL AND EQUIPMENT STORAGE



Product Code	Description	Weight (kg)	External Dimensions W x D x H (mm)	Internal Dimensions W x D x H (mm)
TSC1	TuffStor Cabinet™	44	500 x 530 x 980	490 x 465 x 895
TSC2	TuffStor Cabinet™	74	800 x 585 x 1250	790 x 540 x 1170
TSC3	TuffStor Cabinet™	113	1205 x 580 x 1555	1185 x 510 x 1475

Note: Weights and dimensions are approximate. External dimensions include handles.

The secure storage cabinet designed to keep thieves at bay!

The high value of copper fittings and cabling means that theft is on the rise, with criminals targeting construction sites on a daily basis. Don't make it easy for them! **FittingStor™** is designed to secure all of your costly M&E components and tools in one safe, easily portable location.

# armorgard fittingstor™



» WATCH THE FITTINGSTOR™ IN ACTION

POWDER-COATED FOR MAXIMUM DURABILITY

FITTINGS BINS TOUGH LIFT-OUT PLASTIC FITTINGS BINS SUPPLIED (6 X BINS FOR FC2 AND 15 X BINS FOR FC3)

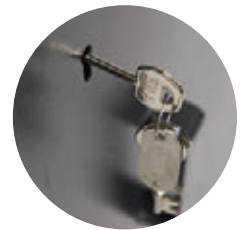

KEYED ALIKE 5-LEVER DEADLOCKS WITH HEAVY-DUTY CHUBB-STYLE KEYS (FC2, FC3, FC4)

ROBUST STEEL PLATE CONSTRUCTION FOR MAXIMUM PROTECTION

STORAGE COMPARTMENT IN THE BASE FOR TOOLS & EQUIPMENT

HEAVY-DUTY INDUSTRIAL CASTORS FITTED AS STANDARD

FC3

FORKLIFT SKIDS FOR EASY TRANSPORTATION



For on-site solutions, call our customer experience team on **023 9238 0280** or email **sales@armorgard.co.uk**



ticking every box

SOCKET WITH INTERLOCK

TOOL AND EQUIPMENT STORAGE

» "THE MOST APPROPRIATE FITTING STORE ON THE MARKET."

# armorgard fittingstor™



FC2 & FC3 - REMOVABLE GALVANISED SHELVES IDEAL FOR LINBINS

FC3



FC2



FC4

NEW BOLT-ON HANDLE MAKES IT EASIER TO USE



NEWLY DESIGNED SHELVES THAT ARE ADJUSTABLE, REMOVABLE AND EASIER TO CONFIGURE

COMES WITH 3 SHELVES AND 4 BRACKETS

NEW SLAM LATCH SYSTEM MAKES IT EASIER TO USE AND MORE SECURE

**FC5**



HASP AND STAPLE PADLOCK FACILITY (FC5)

FC5 & FC6 - FIXED REINFORCED CERTIFIED SHELVES

**FC6**



»  
OPTIONAL EXTRAS



FITTINGS BINS



Product Code	Description	Weight (kg)	External Dimensions W x D x H (mm)	Internal Dimensions W x D x H (mm)
FC2	FittingStor™	89	800 x 555 x 1450	790 x 540 x 1170
FC3	FittingStor™	139	1200 x 550 x 1750	1185 x 510 x 1465
FC4	FittingStor™	125	1120 x 575 x 1580	925 x 510 x 1290
FC5	FittingStor™	160	Open: 1965 x 580 x 1575 Closed: 915 x 990 x 1575	890 x 450 x 300
FC6	FittingStor™	123	1077 x 775 x 1880	880 x 709 x 1592

Note: Weights and dimensions are approximate. External dimensions include handles.

The secure mobile storage trunk that keeps your piping safe and organised

This innovatively designed portable 'copper coffin' gives you peace of mind that your piping is safe from theft. The PipeStor™ accommodates different sizes and styles of pipes, including plastic and metal conduit, trunking and cable tray.

Extremely versatile - it can be extended to accommodate longer lengths by adding sections as required.

# armorgard pipestor™



FACILITY FOR PADLOCK

INTERNALLY DIVIDED INTO 4 SEPARATE COMPARTMENTS

ROBUST STEEL PLATE CONSTRUCTION FOR MAXIMUM PROTECTION



SECURED WITH A 5-LEVER DEADLOCK AND HEAVY-DUTY CHUBB STYLE KEYS

AVAILABLE FOR EITHER 3 M OR 6 M LENGTHS



FORK SKIDS FOR EASY TRANSPORTATION

POWDER-COATED FOR MAXIMUM DURABILITY

FULLY MOBILE WITH HEAVY-DUTY SWIVEL CASTORS

PS3

PS6



For on-site solutions, call our customer experience team on **023 9238 0280** or email **sales@armorgard.co.uk**

Product Code	Description	Weight (kg)	External Dimensions W x D x H (mm)	Internal Dimensions W x D x H (mm)
PS3	3 m PipeStor™	133	575 x 3205 x 785	495 x 3160 x 495
PS6	6 m PipeStor™	256	575 x 6410 x 785	495 x 6350 x 495

Note: Weights and dimensions are approximate. External dimensions include handles.



**A multi-purpose crane and fork-liftable crate for storing and transporting goods and equipment**

Created for the rail industry, but useful for any site or depot, the **TuffCrate™** is designed to hold stress testing kits, but the large capacity means it can be used to store a wide range of equipment, tools and materials.

**armorgard**  
**tuffcrate™**



IDEAL FOR  
STORING STRESS  
TESTING KITS



CRANE LIFTING  
EYES FOR EASY  
MANOEUVRABILITY

LOLER CERTIFIED  
TO LIFT UP TO  
750 KG UDL

SLAMSTOP  
SAFETY LID STAY  
WITH GAS STRUTS

**TC750**

MESH FRONT AND  
BACK ALLOW FOR  
EASY IDENTIFICATION  
OF CONTENTS

FORKLIFT SKIDS

EASILY  
ACCESSIBLE  
WITH FULL-WIDTH  
DOORS

LOCKABLE  
USING PADLOCK

TOOL AND EQUIPMENT STORAGE

Product Code	Description	Weight (kg)	External Dimensions W x D x H (mm)	Internal Dimensions W x D x H (mm)
TC750	TuffCrate™	245	1875 x 935 x 1100	1800 x 800 x 845

Note: Weights and dimensions are approximate. External dimensions include handles.



 **armorgard**  
Protect your assets

**armorgard**

[www.armorgard.co.uk](http://www.armorgard.co.uk)

 **armorgard**  
Protect your assets

 **a**

Our quick-assembly,  
flat-pack, modular  
solution for on-site  
secure storage

Forma-Stor™ is our popular secure store that can be constructed in as little as 10 minutes. With 5-lever deadlocks and jemmy-proof joins, the **Forma-Stor™** is the most robust flat-pack store around. An ideal solution for contractors who need quick and convenient storage, these walk-in units are constructed using galvanised panels that fasten neatly together with very few tools.

**armorgard**

# forma-stor™

CRANE  
LIFTING EYES

AVAILABLE IN 4  
STANDARD SIZES



»  
FORMA-STOR™  
IS DELIVERED  
FLAT-PACKED  
FOR EASY  
TRANSPORTATION

— STACKED FLAT-PACKED  
PANELS

— CAN BE DELIVERED  
PRE-ERECTED AT AN  
ADDITIONAL COST

FR200-T



— FULLY GALVANISED  
AND POWDER-COATED  
FOR MAXIMUM DURABILITY

— KEYED ALIKE 5 LEVER  
DEADLOCKS AND  
JEMMY-PROOF JOINS

— FORKLIFT POCKETS  
FOR EASY  
TRANSPORTATION

— STRONG FITTED  
OSB FLOOR

— ERECTED SIMPLY AND  
EASILY WITH NO FUSS!  
INSTRUCTIONS INCLUDED



»  
WATCH THE  
FORMA-STOR™ BEING  
BUILT IN 6 MINUTES

TOOL AND EQUIPMENT STORAGE

» "STRONG, SECURE AND STURDY. I WOULD CERTAINLY RECOMMEND IT"

 **armorgard**

# forma-stor™



FR100-T



FR300-T





FR400-T

»  
FORMA-STOR™ ACCESSORIES



BLOKKABAR



200 KG CERTIFIED SHELVES



LED LIGHTING

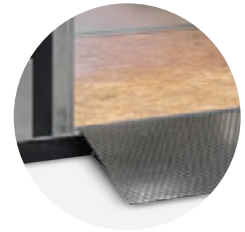

HEAVY-DUTY RAMP



»  
SEE THE ACCESSORIES  
IN ACTION



For on-site solutions, call our customer experience team on **023 9238 0280** or email **sales@armorgard.co.uk**

Individual Panel Weight (kg)	End Panel	Door Panel	Side Panel	Roof Panel	Floor	Total
FR100-T	55.9	75.8	20.7	32.6	57.5	251
FR200-T	55.9	75.8	52.9	52.9	112.3	384
FR300-T	55.9	75.8	69.1	75.8	143	467
FR400-T	55.9	75.8	114	95.2	186	594

Product Code	Description	Weight (kg)	External Dimensions (Including Protrusions) W x D x H (mm)	Internal Dimensions W x D x H (mm)
FR100-T	Forma-Stor™	251	2075 x 1120 x 2160	1920 x 970 x 1950
FR200-T	Forma-Stor™	384	2075 x 2075 x 2160	1920 x 1920 x 1950
FR300-T	Forma-Stor™	467	2075 x 2990 x 2160	1920 x 2840 x 1950
FR400-T	Forma-Stor™	594	2075 x 3995 x 2160	1920 x 3840 x 1950
FRS2	Forma-Stor™ Shelf	20	1970 x 520 x 30	N/A
FRBL2	BlokkaBar	23	1960 x 170 x 110	N/A
FRR4	Forma-Stor™ Ramp	37	1185 x 750 x 100-195	N/A
FRLK-110	110 V Forma-Stor™ Lighting Kit	5	N/A	N/A
FRLK-240	240 V Forma-Stor™ Lighting Kit	5	N/A	N/A

Note: Weights and dimensions are approximate. External dimensions include handles.

The ultra-tough secure vault for storing trimmers and other long handled tools

The **StrimmerSafe Vault™** is a secure storage range specially designed for trimmers and similar long-handled tools. Suitable for use in vehicles or workshops, this highly secure vault benefits from an ultra-tough, anti-force construction and an innovative heavy-duty locking mechanism – once the lid is shut and locked, the trimmer is impossible to remove.



# strimmersafe vault™



KEYED ALIKE 5-LEVER DEADLOCKS



STRONG GAS STRUTS FITTED AS STANDARD - CONFORM TO INDUSTRY STANDARDS



ROBUST CONSTRUCTION FROM HEAVY-DUTY STEEL PLATE THROUGHOUT

POWDER-COATED FINISH FOR MAXIMUM DURABILITY

AVAILABLE IN 3 DIFFERENT SIZES

INTERNAL DIVIDER SYSTEM (EXCEPT THE SSV6)

SSUX6

SNUG STORAGE POSITION KEEPS STRIMMERS SECURE

FULL-LENGTH COVER PLATE FOR USE WHEN STRIMMERS ARE NOT BEING STORED

450 MM



SSV12

445 MM



SSUX6

665 MM



SSV6

Product Code	Description	Weight (kg)	External Dimensions W x D x H (mm)	Internal Dimensions W x D x H (mm)
SSV12	StrimmerSafe Vault™	69	1275 x 515 x 450	1190 x 445 x 445
SSUX6	StrimmerSafe Vault™	63	1800 x 555 x 445	1710 x 480 x 440
SSV6	StrimmerSafe Vault™	141	1970 x 675 x 665	1880 x 605 x 580

Note: Weights and dimensions are approximate. External dimensions include handles.



# strimmersafe rack™

The unique upright storage system for securing your strimmers

Strimmers are among the most commonly stolen power tools. The StrimmerSafe Rack™ is packed full of features to keep your equipment secure and organised whilst maximising on storage space.



KEYED ALIKE 5-LEVER DEADLOCKS WITH HEAVY-DUTY CHUBB STYLE KEYS

SUPPLIED FLAT PACKED

LID IS FITTED WITH 2 GAS STRUTS FOR EASY LIFTING



MUST BE BOLTED TO A WALL TO ENSURE SAFETY

HIGHLY SECURE UNIT TO PROTECT YOUR VALUABLE EQUIPMENT FROM THEFT AND DAMAGE

IDEAL FOR LANDSCAPERS AND GREENKEEPERS



HOOK STORAGE FOR UP TO 6 STRIMMERS

KEEPS STRIMMERS ORGANISED WHILE MAXIMISING STORAGE SPACE

POWDER-COATED FOR MAXIMUM DURABILITY

MULTI-PURPOSE - CAN ALSO BE USED FOR STORING HEDGE CUTTERS, LEAF BLOWERS, CHAINSAWS, ETC

LIQUID-TIGHT BASE CONTAINS ANY ACCIDENTAL SPILLS OF OIL OR FUEL

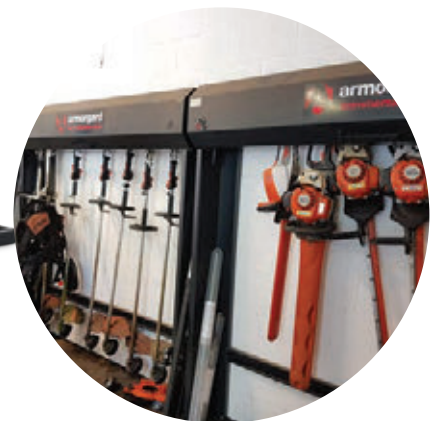

SSR6

TOOL AND EQUIPMENT STORAGE

Product Code	Description	Weight (kg)	External Dimensions W x D x H (mm)	Internal Dimensions W x D x H (mm)
SSR6	StrimmerSafe Rack™	93	2055 x 365 x 2085	N/A

Note: Weights and dimensions are approximate. External dimensions include handles.



## SECTION 02 WORK PLATFORMS AND UNITS







## SECTION 02

### Work platforms and units

instagate™	42
barricade™	44
tuffbench™	45
mobile tuffbench™	46
cuttingstation™	48
sitestation™	52
cuttingcube™	54

An expandable barrier  
for crowd/traffic control  
in any location

InstaGate™ is a quick-to-deploy barrier that's robust and easy to extend to full length. Constructed from strong lightweight aluminium, this durable barrier can be wheeled into position, expanded and braked single-handedly. InstaGate™ forms a highly visible red and white barrier for enhanced safety in any situation, indoors or out.

InstaGate™ is available in two heights (4 ft and 6 ft).



» WATCH THE  
INSTAGATE™  
IN ACTION

# armorgard instagate™

ROBUST DESIGN WITH  
STRONG REINFORCEMENT

ANTI-TRAPPING FINGER  
SAFE SYSTEM TO  
IMPROVE USER SAFETY

POWDER-COATED AND  
WEATHERPROOF

DESIGNED FOR  
HIGH VISIBILITY



SIMPLE-TO-USE CATCH TO  
LOCK IN POSITION AND  
ATTACH MULTIPLE  
BARRIERS TOGETHER FOR  
WIDER OPENINGS

HARD-WEARING  
INTEGRATED BRAKING  
SYSTEM TO SECURE  
IN PLACE

LIGHTWEIGHT, YET  
STRONG AND RIGID

ROBUST, LARGE  
WHEELS ALLOW FOR  
SIMPLE PORTABILITY

IG4



IG4



IG6



» INSTAGATE™ ACCESSORIES



LINKING KIT - SECURELY  
LINK TOGETHER  
MULTIPLE INSTAGATE™



ANCHOR KIT - SAFELY  
FIX YOUR INSTAGATE™  
TO A FLAT SURFACE



» WATCH THE  
ACCESSORIES  
IN ACTION

Product Code	Description	Weight (kg)	Folded Dimensions W x D x H (mm)	Extended Dimensions W x D x H (mm)	External Dimensions W x D x H (mm)
IG4	InstaGate™	30	405 x 535 x 1335	2160 x 535 x 1335	N/A
IG6	InstaGate™	38	415 x 535 x 1900	2300 x 535 x 1900	N/A
IGL1	InstaGate™ Linking Kit	1	N/A	N/A	245 x 80 x 30
IGA1	InstaGate™ Anchor Kit	0.75	N/A	N/A	80 x 145 x 80

Note: Weights and dimensions are approximate. External dimensions include handles.

**The expandable safety barrier**

The **Barricade™** is a highly visible concertina barrier; the perfect partner for those looking to clearly mark out a safe working area. Manufactured with a robust steel channel structure that has no detachable parts and a durable powder-coat finish, the **Barricade™** is built to last.

**Patent number:**  
2109709.2

**armorgard**  
**barricade™**



» WATCH THE BARRICADE™ IN ACTION

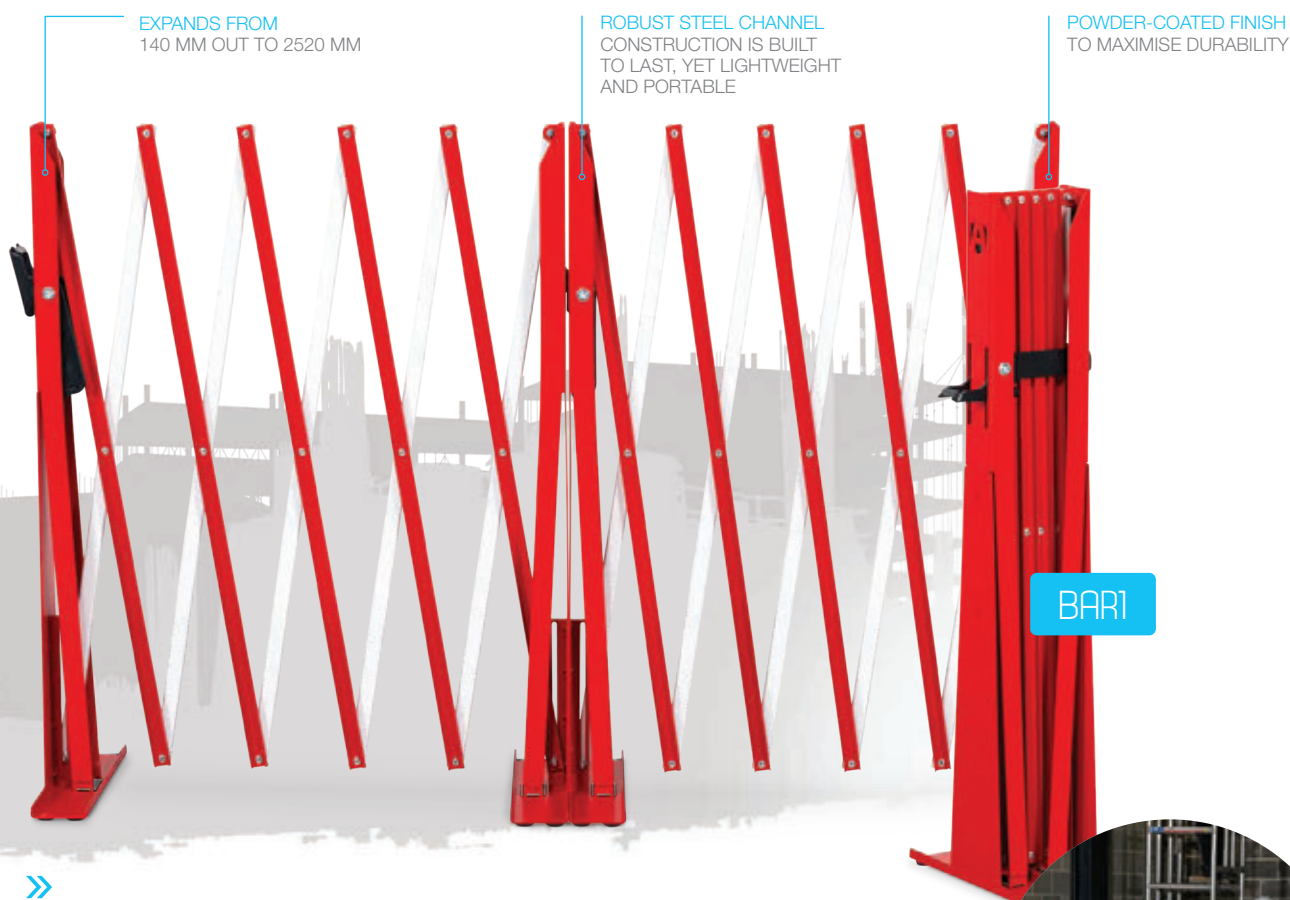

» 3-IN-1 LATCHING SYSTEM



HOLDS THE BARRIER TOGETHER WHEN FOLDED



PRESENTS A HANDLE TO MAKE CARRYING EASIER AND SAFER



ENABLES THE BARRICADE™ TO BE DAISY CHAINED



CONCERTINA BARRIER FOR MARKING OUT SAFE WORKING AREAS

Product Code	Description	Weight (kg)	Extended Dimensions W x D x H (mm)	Folded Dimensions W x D x H (mm)
BAR1	Barricade™	8	2525 x 300 x 830	140 x 300 x 830

Note: Weights and dimensions are approximate. External dimensions include handles.

The versatile and easy-to-use mobile work platform from Armorgard

The TuffBench™ heavy-duty folding work platform is a versatile workbench designed for contractors on the move and for use on construction sites. Its quick and easy assembly system – with no detachable parts – makes it easy to transport and store. When it's time to move on, simply collapse the platform, fold the legs and you're ready to go! Durable and built to last, the surface is manufactured from sustainable pressed timber.

**armorgard**  
**tuffbench™**

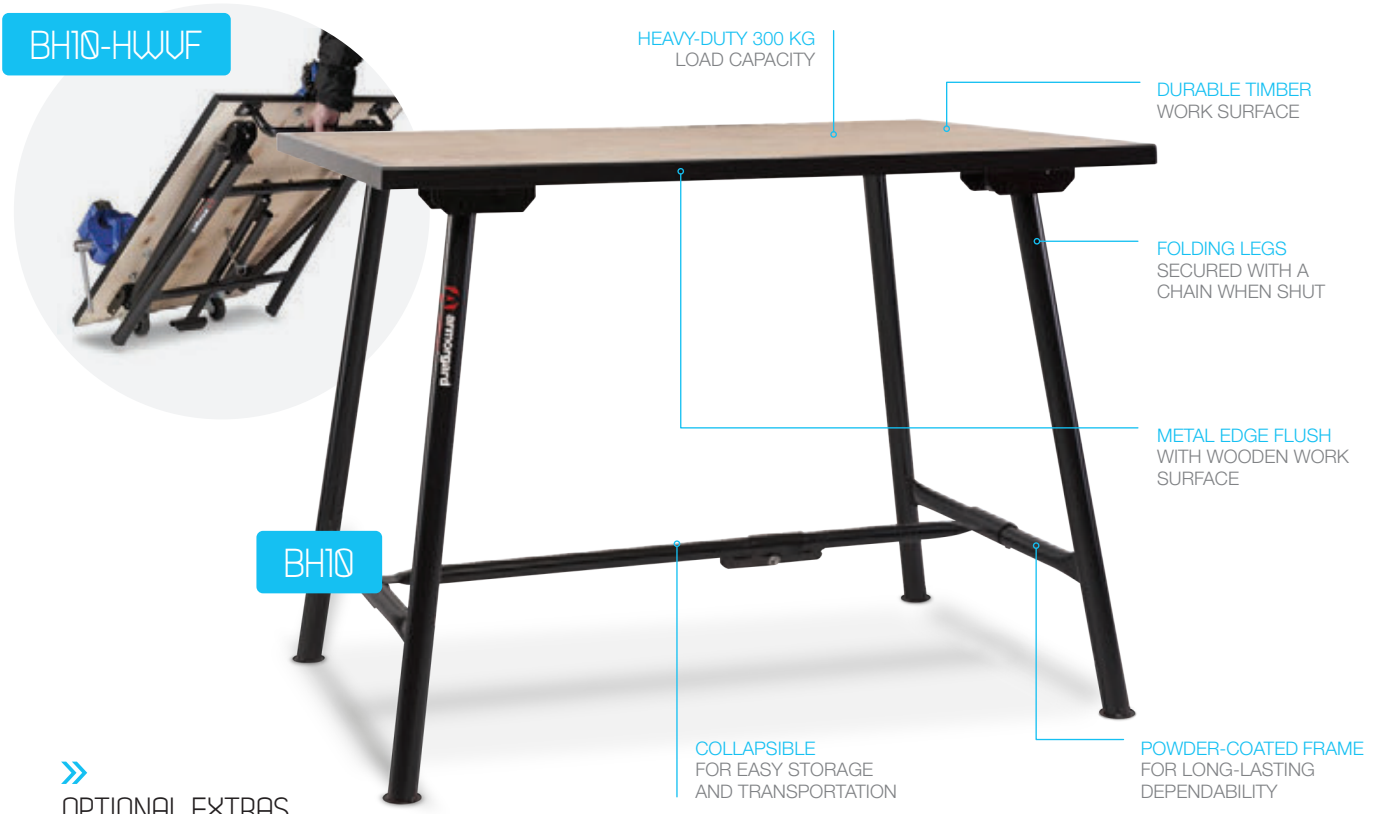

WORK PLATFORMS AND UNITS

» OPTIONAL EXTRAS



6" ENGINEERS' VICE



4" CHAIN VICE



HANDLE AND WHEELS

NO DETACHABLE PARTS  
- STAYS TOGETHER AS ONE UNIT

IDEAL FOR FITTING A CHAIN VICE AND ENGINEERS' VICE TO

Product Code	Description	Weight (kg)	External Dimensions W x D x H (mm)	Folded Down Dimensions W x D x H (mm)
BH10	TuffBench™	28	1080 x 750 x 820	1080 x 750 x 130
BH10-HWF	TuffBench™ with Handle and Wheel Kit	31	1080 x 750 x 820	1080 x 750 x 130
BH10-HWVF	TuffBench™ + c/w Wheels, Handle, Chain Vice and Engineers' Vice	58	1165 x 870 x 1005	1165 x 870 x 315
CV6	6" Engineers' Vice	22	N/A	N/A
CV4	4" Chain Vice	5	N/A	N/A
BH10-HW	Handle and Wheel Kit for TuffBench™	3	N/A	N/A

Note: Weights and dimensions approximate. External dimensions include handles.

The universal mobile workbench that's also a heavy-duty cabinet!

Use the Armorgard **Mobile TuffBench™** for a day and you'll wonder how you ever got by without it. A combination of heavy-duty storage cabinet and multi-purpose work surface, this innovative workbench makes any job that bit easier, while ensuring that your tools and equipment remain safe from thieves and damage. Its ultra-tough surface is ideal for fixing a chain vice, engineers' vice and other equipment, making it indispensable for M&E contractors when pipe threading and bending.

**armorgard**

# mobile tuffbench™

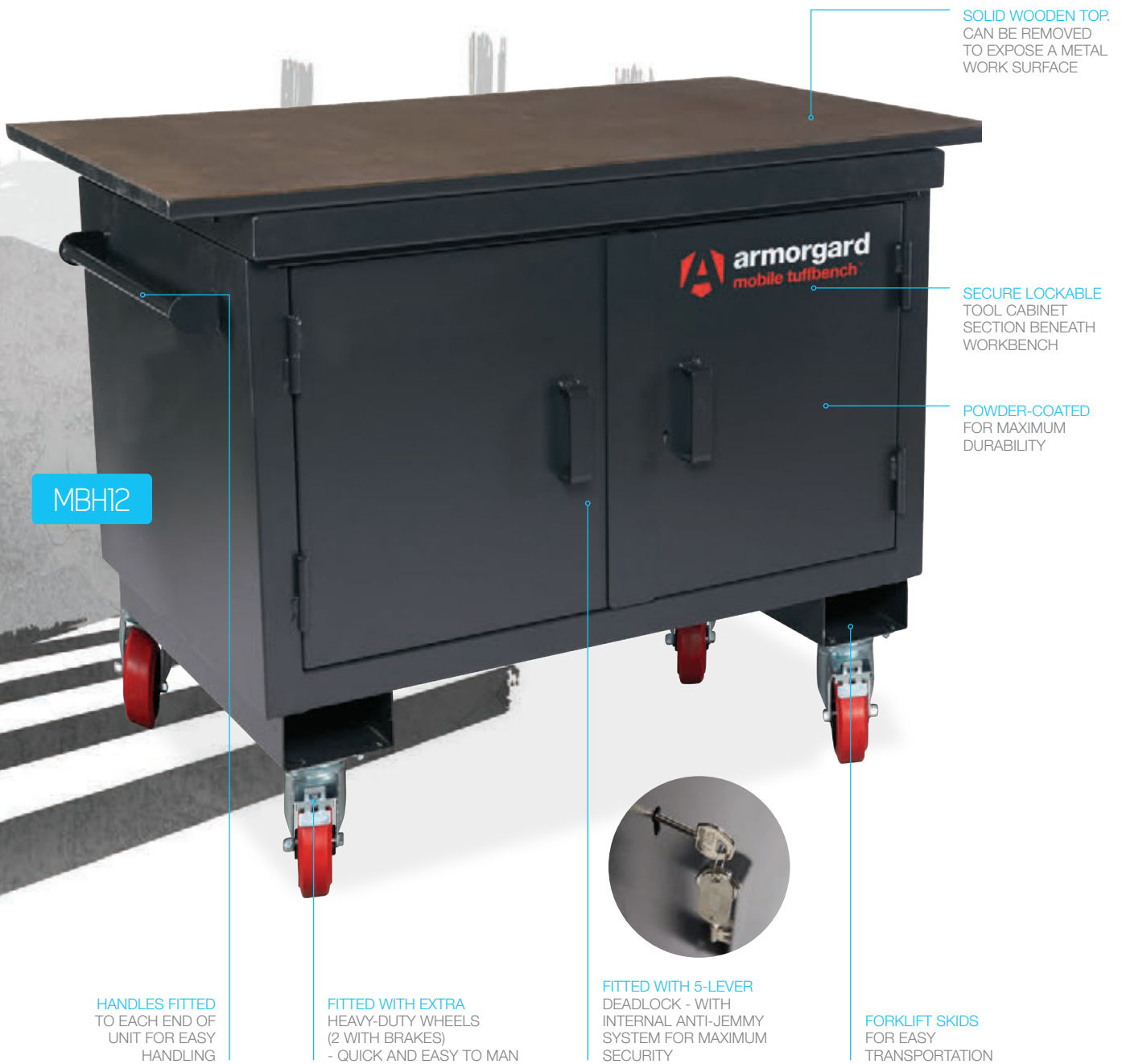



»  
OPTIONAL EXTRAS



6" ENGINEERS' VICE

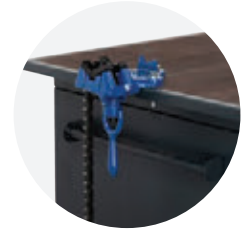

4" CHAIN VICE



MBH12-VF

Product Code	Description	Weight (kg)	External Dimensions W x D x H (mm)	Internal Dimensions W x D x H (mm)
MBH12	Mobile TuffBench™	96	1200 x 700 x 950	1000 x 630 x 615
MBH12-VF	Mobile TuffBench™ with Vices Fitted	125	1200 x 705 x 940	990 x 630 x 640

Note: Weights and dimensions are approximate. External dimensions include handles.

**A go-anywhere,  
multi-purpose cutting  
station with unrivalled  
safety features to  
minimise vibration,  
sparks, noise and dust**

Our ever-popular Armorgard **CuttingStation™** is a neat mobile workstation that eliminates the need for a separate cutting room and is essential for safely cutting lengths of material, such as conduit, timber, cable tray and pipe. The SS7 model includes lighting and chamfered corners to further reduce noise. You'll also find a new expandable working area to accommodate mitre saws and cutaway sides for handling longer materials.

**Patent number:  
17183824.6 (SS7)**

# **armorgard** **cuttingstation™**

SWarf COLLECTOR  
WITH DUST EXTRACTOR  
CONNECTION

ADAPTABLE PVC  
CURTAINS TO  
CONTAIN SPARKS

RUBBER MAT  
TO REDUCE  
VIBRATION



**SS7**

RUBBERISED  
WHEELS FOR  
REDUCED  
VIBRATION

SECURE CABINET  
TO KEEP YOUR  
TOOLS SAFE



RECESSED 110 V  
INLET POWER  
SUPPLY, 2 X 110 V  
INTERNAL SOCKETS,  
AND LIGHT

EXTENDABLE  
SUPPORT ARMS  
WITH 4  
CONFIGURATIONS

KEYED ALIKE  
5-LEVER  
DEADLOCK WITH  
CHUBB-STYLE  
KEYS

**European Patent  
Application Number:  
EP17183824.6**

**European Community  
Design Registration  
Number: 004511525**



**armorgard**  
cuttingstation™

WORK PLATFORMS AND UNITS

**armorgard**  
**cuttingstation™**

»  
 OPTIONAL EXTRAS



SS7C

SS7C UNIVERSAL CLAMP HOLDS ELECTRIC SAWS IN PLACE TO IMPROVE HEALTH AND SAFETY. COMPATIBLE WITH SS7 AND SS7X

EXTRACTION SYSTEM  
 HELPS TO CONTAIN DUST AND REDUCES EXPOSURE TO HARMFUL SUBSTANCES



LIFTING EYES TO ALLOW FOR TRANSIT BY CRANE



SS7X



FORK SKIDS FOR EASY TRANSPORTATION

WORKS PERFECTLY WITH THE HUSQVARNA AIR SCRUBBER

Patent number:  
 17183824.6 (SS7X)

HEAVY-DUTY ALL-SWIVEL WHEELS FOR GOOD MOBILITY

»  
 For on-site solutions, call our customer experience team on **023 9238 0280** or email **sales@armorgard.co.uk**



EASY ACCESS  
WITH CUT-OUT  
FRONT



PROVISION FOR  
ATTACHING A  
VACUUM HOSE

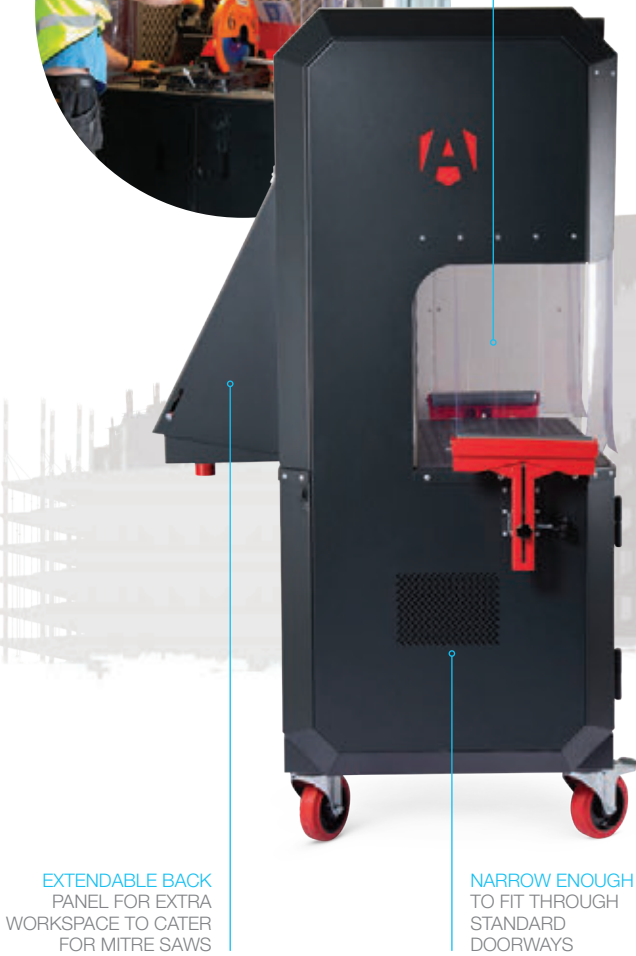

EXTENDABLE BACK  
PANEL FOR EXTRA  
WORKSPACE TO CATER  
FOR MITRE SAWS

NARROW ENOUGH  
TO FIT THROUGH  
STANDARD  
DOORWAYS



»  
THE 4 CONFIGURATIONS OF THE  
EXTENDABLE SUPPORT ARMS



FLAT SURFACE  
IDEAL FOR LONG  
LENGTHS



ROLLER SURFACE  
IDEAL FOR LONG  
LENGTHS



V-SHAPE  
IDEAL FOR  
ROUND PIPES



FLAT EDGE  
IDEAL FOR LONG  
LENGTHS

Product Code	Description	Weight (kg)	External Dimensions W x D x H (mm)	Internal Dimensions W x D x H (mm)
SS7	CuttingStation™	175	Standard: 1390 x 780 x 1900 Extended: 3225 x 1090 x 1900	Top (With Extended Back): 1125 x 955 x 1000 Bottom: 1125 x 710 x 550
SS7X	CuttingStation™ with Extraction System	200	Standard: 1390 x 780 x 1900 Extended: 3225 x 1090 x 1900	Top (With Extended Back): 1125 x 955 x 1000 Bottom: 1125 x 710 x 550
SS7C	CuttingStation™ Clamp	4	1000 x 550 x 30	N/A

Note: Weights and dimensions are approximate. External dimensions include handles.

**A purpose-built solution for your on-site work station needs**

The innovatively designed Armorgard SiteStation™ gives you a convenient place for routine on-site tasks, while also providing secure storage for your valuable equipment. The top section features a folding slanted work surface – ideal for displaying plans and charts – that provides additional lockable storage when shut – ideal for power tools, PPE and fixings.

# armorgard sitestation™



For on-site solutions, call our customer experience team on **023 9238 0280** or email **sales@armorgard.co.uk**



WORK PLATFORMS AND UNITS



» WATCH THE SITESTATION™ IN ACTION

Product Code	Description	Weight (kg)	External Dimensions W x D x H (mm)	Internal Dimensions W x D x H (mm)
SS2	SiteStation™	223	1400 x 845 x 1970	Top: 1300 x 800 x 1065 Bottom: 1300 x 800 x 610

Note: Weights and dimensions are approximate. External dimensions include handles.

» "IT REDUCES THE RISKS AROUND DUST, SAFELY CONTAINS SLURRY AND REDUCES NOISE FOR PEDESTRIANS"

**Reduce noise pollution when cutting masonry and safely contain dust and slurry**

Creating a designated, time-saving, portable area for safe cutting, the **CuttingCube™** is a purpose-built, portable unit that contains dust and slurry and reduces the noise pollution created when cutting masonry on site. Prioritising the safety and efficiency of both workers and projects, the **CuttingCube™** has quickly established itself as best practice. Featuring an easy-empty sump to contain the slurry, as well as durable, washable acoustic absorption panels, it's a product that is built to last.

**armorgard**  
**cuttingcube™**



LIFTING EYES FOR CRANE LIFTING

HEAVY-DUTY DOORS WITH 5-LEVER DEADLOCKS AND JEMMY-PROOF JOINS

ACOUSTIC SOUND PANELS ACROSS THREE SIDES REDUCES NOISE POLLUTION BY UP TO 22 DB

CAN BE USED AS A SECURE TOOL AND EQUIPMENT STORAGE UNIT WHEN NOT USED FOR CUTTING

CAN BE USED AS A SECURE TOOL AND EQUIPMENT STORAGE UNIT WHEN NOT USED FOR CUTTING

CC200

2" THREADED SUMP PLUG TO ALLOW TO CONNECT TO DRAINAGE AND CONTAINMENT TANKS FOR DISPOSAL

EQUIPPED WITH CATCHES FOR SAFELY SECURING THE DOORS OPEN DURING USE



BUILT-IN 110 V LED STRIP LIGHTS FOR VISIBILITY



» WATCH THE CUTTINGCUBE™ IN ACTION

Product Code	Description	Weight (kg)	External Dimensions W x D x H (mm)	Internal Dimensions W x D x H (mm)
CC200	CuttingCube™	460	2075 x 2005 x 2190	1910 x 1840 x 1910

Note: Weights and dimensions are approximate. External dimensions include handles.



WORK PLATFORMS AND UNITS



**SECTION 03**  
**WELFARE**  
**PRODUCTS**







## SECTION 03

### Welfare products

scrubkart™ .....	58
forma-shelta™ .....	59
sanistation mini™ .....	60
sanistation™ .....	61

The mobile instant warm water hand washing unit, purpose-built for sites

Take sanitising to the next level with **ScrubKart™**, our mobile hot or cold hand washing unit. With instant warm water by your side, a heavy-duty steel construction and robust solid rubber puncture-proof tyres to take on rougher terrains, it is a solution that is built to last.

Patent number:  
2006552.0

**armorgard**  
**scrubkart™**

UP TO 120 HAND WASHES PER TANK

SOAP DISPENSER

BUILT-IN PAPER TOWEL DISPENSER

SBKIT

Kick here to open

SOLID RUBBER TYRES  
EASILY MANOEUVRED  
BY ONE INDIVIDUAL

FOOT PUMP  
OPERATED TAP



STAINLESS STEEL  
SINK AND TAP



HANDS-FREE  
FOOT-OPERATED BIN

WATER HEATER  
AVAILABLE IN  
110 V OR 240 V



» WATCH THE  
SCRUBKART™  
IN ACTION

MAINS-FED  
OPTION AVAILABLE  
ON REQUEST

Product Code	Description	Weight (kg)	External Dimensions W x D x H (mm)	Internal Dimensions W x D x H (mm)
SBK1T	ScrubKart™ 110 V Tank Fed	122	790 x 870 x 1450	N/A
SBK2T	ScrubKart™ 240 V Tank Fed	122	790 x 870 x 1450	N/A
SBK3T	ScrubKart™ Tank Fed Cold Water	114	790 x 870 x 1450	N/A

Note: Weights and dimensions are approximate. External dimensions include handles.

**A purpose-built shelter,  
providing a designated,  
safe area with protection  
from the elements**

The flat-packed design of the **Forma-Shelta™** means it can be constructed where needed in as little as 10 minutes. Coupled with crane lifting eyes and fork pockets for ease of transportation.

The perfect solution for contractors searching for a sturdy, built-to-last unit that encourages users to stay in designated areas only when choosing to smoke/vape.



# forma-shelta™



» WATCH THE  
FORMA-SHELTA™  
IN ACTION

Product Code	Description	Weight (kg)	External Dimensions W x D x H (mm)	Internal Dimensions W x D x H (mm)
FR200-S	Forma-Shelta™	275	2080 x 2100 x 2070	Bench Height: 425

Note: Weights and dimensions are approximate. External dimensions include handles.

**Robust hand sanitiser stations for internal high-traffic environments**

There's a **SaniStation Mini™** for every need, whether you're looking for a hands-free unit, a simple stand or a wall-mounted option.

With an anti-theft system fitted as standard and a low dosage pump to reduce spillage, you can rest assured that the **SaniStation Mini™** will deliver every time when it comes to protecting welfare.



# sanistation mini™

FITTED TO WALL BY A SIMPLE WALL-MOUNTED BRACKET

LOW DOSAGE 5 L BOTTLE PUMP (2 ML) TO REDUCE SPILLAGE

SAN-BWM

S10WM

S10HF

SECURITY CLAMP TO HOLD AND PREVENT THE BUCKET FROM BEING REMOVED

S10S



» WATCH THE SAN-BWM IN ACTION

BUILT-IN SECURE STORAGE FOR EXTRAS (S10HF)

FOOT OPERATED DISPENSER FOR HANDS-FREE USE

ALL SANISTATION MINI™ COMPATIBLE WITH ALL STANDARD 5 L BOTTLES

CAN BE FREE STANDING OR FIXED TO THE FLOOR

Product Code	Description	Weight (kg)	External Dimensions W x D x H (mm)	Internal Dimensions W x D x H (mm)
S10HF	SaniStation Mini™ Hands Free	15	155 x 275 x 1015 (Base Plate: 400 x 325)	N/A
S10S	SaniStation Mini™ Standard	12	200 x 1000 (Base Plate: 400)	N/A
S10WM	SaniStation Mini™ Wall Mounted	2	200 x 240	N/A
SAN-BWM	Wall-Mounted Bucket Holder	1	248 x 243 x 114	Ø205

Note: Weights and dimensions are approximate. External dimensions include handles.

Unique solution for the immediate deployment of a central sanitising and noticeboard station

Heavy-duty castors make the SaniStation™ a completely mobile unit that can provide relevant welfare where it's needed most. With its double-sided board, it is completely customisable for sanitising products, first aid, fire safety, and health and safety. The ultimate purpose-built on-site solution.

**armorgard**  
**sanistation™**

BOTH SIDES CAN BE UTILISED



S20

RELEVANT SANITISING SIGNAGE INCLUDED AS STANDARD



EASILY RELOCATABLE WITH TWO WHEELS

»  
OPTIONAL EXTRAS



ALCOHOL AND ALCOHOL-FREE HAND SANITISER GEL AND WIPES



MANUAL AND AUTOMATIC DISPENSERS



SEALED LOCKABLE COMPARTMENT WITH PADLOCK FACILITY



»  
WATCH THE SANISTATION™ S20 IN ACTION

Product Code	Description	Weight (kg)	External Dimensions W x D x H (mm)	Internal Dimensions W x D x H (mm)
S20	SaniStation™	26.5	700 x 600 x 1725	N/A

Note: Weights and dimensions are approximate. External dimensions include handles.

WELFARE PRODUCTS



**SECTION 04**  
**MANUAL**  
**HANDLING**  
**PRODUCTS**





---

## SECTION 04

### Manual handling products

piperack™	64
ductrack™	68
bundlerack™	70
loadall™	71
rubble truck™	76
flexikart™	78
v-kart™	80
beamkart™	80
turntable truck™	81
t-kart™	82
spoolkart™	84



**armorgard**  
cutting &...

armo

**armorgard**  
cutting &...



The adaptable mobile on-site pipe and conduit storage solution

The Armorgard PipeRack™ is an innovatively designed wheeled storage rack that keeps your pipes organised and easy to manoeuvre whilst working on-site. Each unit has been tested and certified to guarantee a top-quality product that is durable and built to last. The fully collapsible design means that it can be easily transported and stored when not in use. PipeRack™ is available with either a 1-tonne or 2-tonne capacity.

**armorgard**  
**piperack™**



STACKABLE  
UP TO 6 UNITS HIGH

ALL STEEL  
HEAVY-DUTY  
CONSTRUCTION

POWDER-COATED  
FINISH FOR ULTIMATE  
PROTECTION

UNIQUE FULLY  
FOLDING DESIGN

FITTED WITH  
ULTRA-ROBUST  
INDUSTRIAL  
SWIVEL CASTORS

MANUAL HANDLING PRODUCTS



For on-site solutions, call our customer experience team on **023 9238 0280** or email **sales@armorgard.co.uk**

» INNOVATIVE AND UNIQUE  
FULLY FOLDING DESIGN

**armorgard**  
**piperack™**

PRI

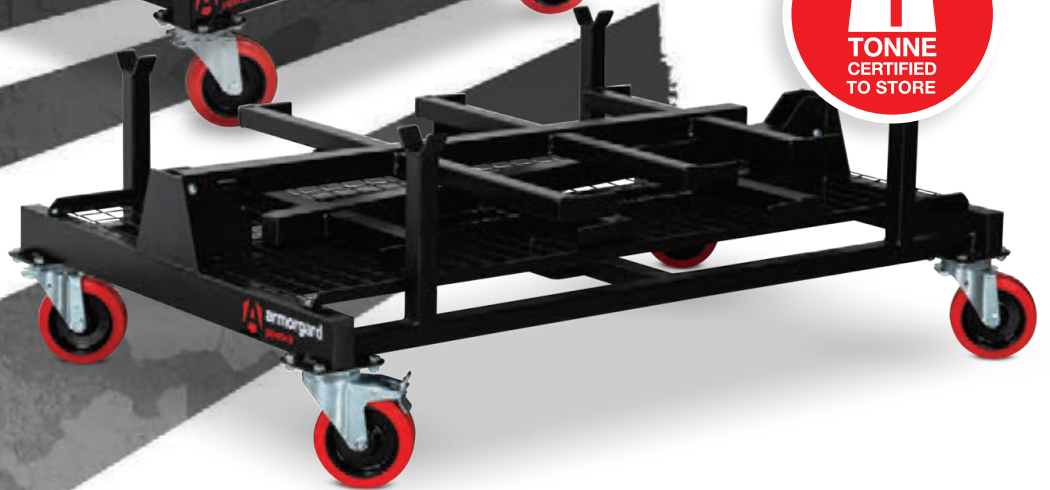
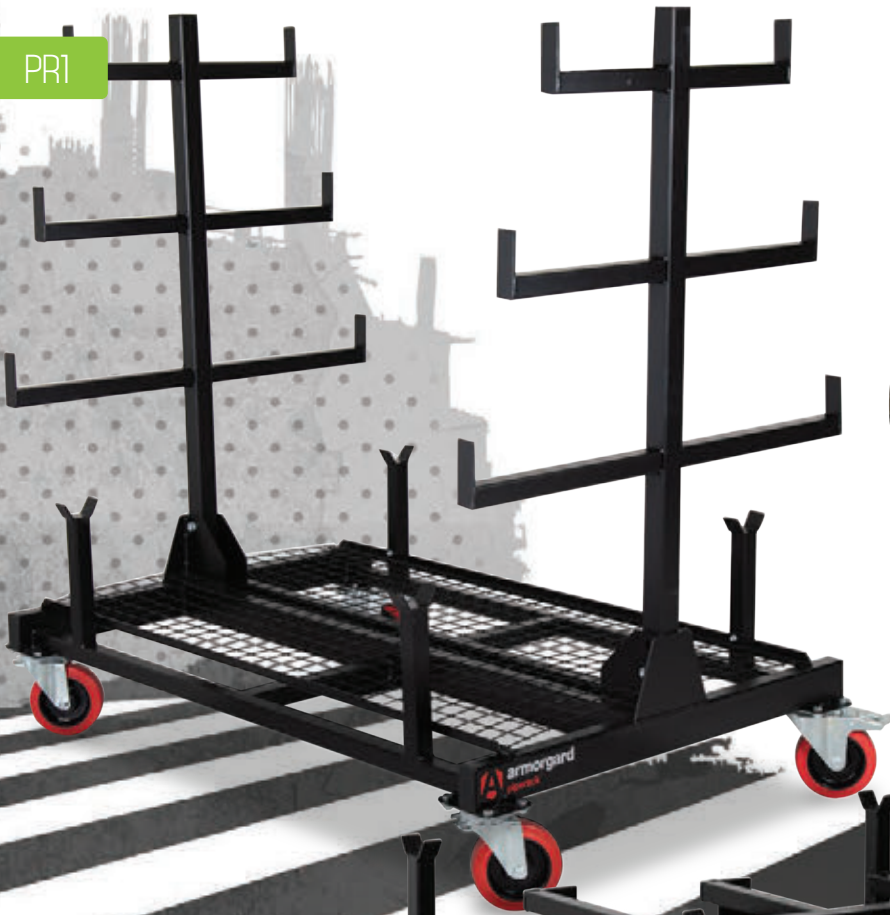



»  
OPTIONAL EXTRAS



STRONG ATTACHABLE  
SAFETY HANDLE



LINKING KIT TO JOIN  
THE TWO PIPERACK™  
TOGETHER (PR-LK)



UPGRADE KIT FROM  
1-TONNE TO 2-TONNE  
CAPACITY (PR-UK)



CASTOR DIRECTION  
LOCK ADAPTORS  
(CAS-DLF)

Product Code	Description	Weight (kg)	External Dimensions W x D x H (mm)	Folded Down Dimensions W x D x H (mm)	Load Capacity
PR1	PipeRack™	83	1010 x 1565 x 1570	1010 x 1565 x 550	1 Tonne
PR2	PipeRack™	101	1010 x 1565 x 1570	1010 x 1565 x 550	2 Tonne
PR-SH	PipeRack™ Handles	0.6	94 x 165 x 90	N/A	N/A
PR-LK	PipeRack™ Linking Kit	15	N/A	N/A	N/A
PR-UK	PipeRack™ Upgrade Kit	20	N/A	N/A	N/A

Note: Weights and dimensions are approximate. External dimensions include handles.

Simplify the way you store, move and protect ducting and pipework

Patent number:  
2113661.9

The **DuctRack™** simplifies and promotes safe and efficient storage, transportation and protection of ducting and pipework on site. Save time and money and ensure user safety is always front of mind. Operable by multiple or single workers, the **DuctRack™** makes light work of moving large loads around site.

**armorgard**  
**ductrack™**



BUILT-IN COVER TO PROTECT WORKERS FROM SHARP EDGES AND REDUCE DUST INGRESS

CENTRALLY LOCATED WHEELS FOR A MINIMAL TURNING CIRCLE

SIMPLY RELEASE ANY OF THE 4 HANDLES TO BRAKE, RAISE ANY OF THE 4 HANDLES TO DISENGAGE THE BRAKE

OPTIONAL EXTRA SHELF AND SIDE KITS FOR IMPROVED ORGANISATION, STORAGE AND SAFETY



For on-site solutions, call our customer experience team on **023 9238 0280** or email **sales@armorgard.co.uk**

» "THE DUCTRACK™ ENABLES US TO TRANSPORT DUCTWORK AROUND SITE COMFORTABLY AND SAFELY"



FOLD DOWN AND STACK THE UNIT TO SAVE SPACE WHEN NOT IN USE



A SINGLE OPERATOR CAN PICK UP ANY OF THE 4 HANDLES TO MOVE WITH EASE

A ROBUST RACK FOR SAFELY STORING AND TRANSPORTING LONG MATERIALS OR DUCTWORK



» WATCH THE DUCTRACK™ IN ACTION

SAFESTOP™ DEADMAN BRAKING SYSTEM ENABLES COMPLETE CONTROL

Product Code	Description	Weight (kg)	External Dimensions W x D x H (mm)	Folded Dimensions W x D x H (mm)
DR1	DuctRack™	138	1835 x 750 x 1860	1835 x 750 x 740
DR2	DuctRack™	158	1835 x 1140 x 1860	1835 x 1140 x 740
DR-SK	DuctRack™ Side Kit	6	1820 x 2 x 200	N/A
DR1-S	DuctRack™ DR1 Shelf	17	1820 x 540 x 145	N/A
DR2-S	DuctRack™ DR2 Shelf	24	1820 x 930 x 145	N/A

Note: Weights and dimensions are approximate. External dimensions include handles.

The mobile rack for easy transport and storage of large bundles of materials

The Armorgard **BundleRack™** is a simple and effective means of transporting and storing large bundles of materials. It allows you to organise your materials on-site to optimise space, while ensuring they are quick and easy to move when needed. Designed to a high-quality, heavy-duty specification with a powder-coated finish, **BundleRack™** is built to last. The unit can be folded and stacked for easy storage when not in use.

**armorgard**  
**bundlerack™**



BR1

STACKABLE UP TO 6 UNITS HIGH

ROBUST CONSTRUCTION AND WEIGHT LOAD TESTED TO CARRY UP TO 1 TONNE

INTEGRAL MESH BASE FOR CARRYING SMALLER ITEMS

POWDER-COATED FOR MAXIMUM DURABILITY

FOLDABLE AND STACKABLE FOR EASY STORAGE

SIDE-LOADING PROVISION FOR LOADING AND UNLOADING MATERIALS USING A FORKLIFT

HEAVY-DUTY SWIVEL WHEELS - TWO WITH BRAKES

Product Code	Description	Weight (kg)	External Dimensions W x D x H (mm)	Folded Down Dimensions W x D x H (mm)	Load Capacity
BR1	BundleRack™	79	1005 x 1560 x 1010	1005 x 1560 x 550	1 Tonne

Note: Weights and dimensions are approximate. External dimensions include handles.

The unique space-saving trolley for transporting large sheets of board

Save space, make handling easier and protect your materials from damage using **LoadAll™ LA750**. Whether in the yard or on-site, transporting large sheets of board has never been easier. Specially designed for storing and transporting plasterboard and other large sheet materials.

**armorgard**

# loadall™ LA750



ROBUST CONSTRUCTION  
USING 3 MM STEEL

SIDE-LOADING FACILITY  
WITH EASY-GRAB HANDLES

LA750

H-FRAME DESIGN FOR  
EASE OF TRANSPORTING  
THROUGH DOORWAYS  
AND NARROW SPACES

HEAVY-DUTY CASTORS  
SUPPLIED AS STANDARD  
- ALL SWIVEL WHEELS  
(TWO BRAKED)



EASILY COLLAPSED WITH  
STORAGE PROVISIONS FOR  
THE UPRIGHT SUPPORTS

MANUAL HANDLING PRODUCTS





The unique space-saving trolley for transporting large sheets of board

Save space, ease manual handling and protect your materials with the **LoadAll™ LA750-PRO**. The combination of the H-frame design and innovative clamping system with the swivel wheels and telescopic handle make the LA750-PRO easy to manoeuvre when carrying a full load of sheet materials through doorways and around corners.

**armorgard**

# loadall™ LA750-PRO



LA750-PRO



SECURE THE LOAD WITH UNIQUE CLAMP SYSTEM

UNIQUE H-FRAME DESIGN MAKES ACCESS THROUGH DOORWAYS EASIER

EXTENDING HANDLE TO ACCOMMODATE DIFFERENT BOARD SIZES

SIDE-LOADING FACILITY WITH EASY-GRAB HANDLES

ROBUST CONSTRUCTION USING 3 & 5 MM STEEL

CAN BE EASILY COLLAPSED WITH NO DETACHABLE PARTS



HEAVY-DUTY CASTORS ALL SWIVEL AND 2 BRAKED FOR MAXIMUM CONTROL OF UNIT

ROBUST POWDER COAT



» WATCH THE LOADALL™ LA750-PRO IN ACTION

MANUAL HANDLING PRODUCTS

The unique space-saving trolley for transporting large sheets of board

LoadAll™ LA1000 is the only trolley of its kind on the UK market that can be folded and stacked when not in use. It also has no detachable parts! Its A-frame design allows it to be loaded on both sides maximising its space-saving efficiencies.

**armorgard**

# loadall™ LA1000



LA1000

**CENTRE A-FRAME DESIGN**  
MEANS THAT WHEN LOADED, ALL WEIGHT IS LEANING INTO THE CENTRE

**CARRIES UP TO 24 SHEETS**  
OF PLASTERBOARD  
- APPROXIMATELY 60%  
MORE THAN ALTERNATIVE  
PRODUCTS

**PROVISION FOR STRAPPING**  
BOARDS IN PLACE  
- IMPROVING SAFETY WHEN  
ON-SITE

**COMPLETE WITH SAFE**  
WORKING LOAD PLATES,  
CERTIFYING A CAPACITY  
OF UP TO 1 TONNE

**HEAVY-DUTY CASTORS**  
FOR EASY MOBILITY



**ONE-PIECE DESIGN**  
KEEPS UNIT TOGETHER AND  
PREVENTS LOSS OF PARTS



**FOLDING & STACKABLE UNIT**  
- TIDY AND EASY TO STORE  
WHEN NOT IN USE

**A unique space-saving trolley for transporting large sheets of material**

Ease manual handling, save space and protect your materials from damage with the **LA1500**. Specially designed for storing and transporting large sheet materials. The wooden slats make it a great option for moving large sheets of glass too.



# loadall™ LA1500



LA1500

**STURDY CONSTRUCTION**  
OUT OF 50 X 50 MM AND  
50 X 25 MM BOX SECTION

**FIXING POINTS TO SECURE  
THE MATERIALS TO  
THE TROLLEY**



**200 MM DIAMETER WHEELS**  
- ALL SWIVEL, 2 COMPLETE  
WITH BRAKES



MANUAL HANDLING PRODUCTS

Product Code	Description	Weight (kg)	External Dimensions W x D x H (mm)	Folded Down Dimensions W x D x H (mm)	Load Capacity
LA750	750 kg LoadAll™	41	550 x 1350 x 1130	550 x 1350 x 300	750 kg
LA1000	1 Tonne LoadAll™	49	730 x 1250 x 1410	730 x 1250 x 495	1 Tonne
LA1500	1.5 Tonne LoadAll™	125	900 x 2020 x 1550	N/A	1.5 Tonne
LA750-PRO	750 kg LoadAll™ with Clamp	70	1705 x 550 x 1305 Extended: 2305 x 550 x 1805	N/A	750 kg

Note: Weights and dimensions are approximate. External dimensions include handles.

**Our multi-purpose Rubble Truck™ features an in-built tipping feature, ideal for handling waste and rubble**

Ergonomically designed for maximum performance and efficiency, the **Rubble Truck™** has an array of unique features to create an indispensable on-site companion. Our multi-purpose **Rubble Truck™** features a huge 400-litre capacity scoop, extra strength crane lifting eyes, and solid rubber wheels. When the day's over, the unique stackable design means you can maintain a working space that's safe and clutter-free.

**armorgard**

# rubble truck™



CRANE LIFTING EYES  
- WELDED FOR  
EXTRA STRENGTH



RUBBER BUFFERS  
FOR SIDE PROTECTION

OVER 400 L  
CAPACITY SCOOP

EASY UNLOADING



RT400

BUILT-IN  
TIPPING FEATURE

SOLID RUBBER  
PUNCTURE  
PROOF WHEELS

ROBUST  
CONSTRUCTION  
ENGINEERED  
FOR HEAVY USE

IDEAL FOR HANDLING  
MATERIALS, WASTE  
OR RUBBLE



For on-site solutions, call our customer experience team on **023 9238 0280** or email **sales@armorgard.co.uk**

UNIQUE STACKABLE DESIGN



»  
OPTIONAL EXTRA



RT-L



HEAPED LID TO  
PREVENT ITEMS INSIDE  
FALLING OUT. INCREASES LOAD  
CAPACITY BY UP TO 160 L

Product Code	Description	Weight (kg)	External Dimensions W x D x H (mm)	Internal Dimensions W x D x H (mm)	Load Capacity
RT400	Rubble Truck™	88.5	760 x 1460 x 855	675 x 1330 x 650	750 kg
RT-L	Rubble Truck™ Lid	19	770 x 1405 x 260	580 x 1400 x 210	N/A

Note: Weights and dimensions are approximate. External dimensions include handles.

**A multi-purpose, space-saving, stackable, sturdy and ergonomically friendly unit**

Mobilise your materials with the **Flexikart™**, a safe, multi-purpose folding pallet skate. With a 750 kg load capacity, this super-neat and sturdy trolley is ideal for storing materials off the ground and moving them around on-site, even through narrow corridors and doorways.

**armorgard**  
**flexikart™**

ABLE TO HOLD 1200 X 1000 PALLETS WHEN ALL 4 SUPPORT ARMS ARE LOCKED UPRIGHT

ALL 4 SUPPORT ARMS CAN BE RAISED INDIVIDUALLY AS REQUIRED, AND WHEN NOT IN USE, THEY FOLD BELOW THE BED HEIGHT

WITH THE SUPPORT ARMS FOLDED DOWN, THE FLEXIKART™ CAN ACCOMMODATE LARGER LOADS, OR CAN BE TWINNED WITH A SECOND FLEXIKART™ FOR LONG LOADS SUCH AS METAL BEAMS, WOOD, PIPE, CONDUIT AND OTHER MATERIALS

FK2



A ROBUST PALLET SKATE WHICH INCREASES SAFETY AND REDUCES PHYSICAL STRAIN WHEN MANOEUVRING LOADS MANUALLY

BUILT-IN LASHING POINTS ALLOW LOADS TO BE SECURED, WHICH SAFELY PREVENTS THEM FALLING OFF WHEN MANOEUVRING

FOUR SWIVEL CASTORS (TWO BRAKED) FOR EASY MANOEUVRABILITY

STACKABLE FOR MAXIMUM SPACE EFFICIENCY



For on-site solutions, call our customer experience team on **023 9238 0280** or email **sales@armorgard.co.uk**

Product Code	Description	Weight (kg)	External Dimensions (Unfolded) W x D x H (mm)	Folded Down Dimensions W x D x H (mm)	Load Capacity
FK2	FlexiKart™	62	1270 x 755 x 1010	1270 x 755 x 395	750 kg

Note: Weights and dimensions are approximate. External dimensions include handles.



# armorgard v-kart™

A heavy-duty cart used for handling long lengths of material

Designed to make life easier for those manoeuvring pipe, steel sections and other round lengths of material on construction sites.



POWDER COAT WITH ANTI-CORROSIVE UNDERCOAT

SOLID RUBBER WHEELS

STURDY HANDLE HELPS TO REDUCE BACK STRAIN DURING USE



VK2

Product Code	Description	Weight (kg)	External Dimensions W x D x H (mm)	Internal Dimensions W x D x H (mm)
VK2	V-Kart™	35	1220 x 840 x 900	Up to Ø400

Note: Weights and dimensions are approximate. External dimensions include handles.

# armorgard beamkart™

Designed to be a heavy-duty kart, ideal for handling long lengths of material

The **BeamKart™** is designed for the effortless transportation of beams and steels. Robust enough for life on-site, yet nimble enough to quickly become an essential for the everyday movement of heavy and bulky items. The **BeamKart™** boasts puncture-proof solid rubber tyres, is available in two sizes and is finished to the standards you've come to expect from Armorgard.



ROBUST CONSTRUCTION USING 3 MM STEEL

POWDER-COATED FINISH FOR MAXIMUM DURABILITY

BK2 HAS NO UPRIGHT SIDES. ENABLES HANDLING OF WIDER MATERIALS

PUNCTURE-PROOF TYRES FOR EASY AND SAFE MANOEUVRING ON-SITE

BK1

BK2

Product Code	Description	Weight (kg)	External Dimensions W x D x H (mm)	Internal Dimensions W x D x H (mm)	Load Capacity
BK1	BeamKart™	19.8	560 x 510 x 250	345 mm Between Lugs	500 kg
BK2	BeamKart™	27	400 x 510 x 275	N/A	500 kg

Note: Weights and dimensions are approximate. External dimensions include handles.



For transporting bulk quantities of material and equipment

Our Turntable Truck™ has been engineered to take the full strain of transporting bulk quantities of material and equipment when you really need it, reducing the physical impact for workers on construction sites.



# turntable truck™

POWDER-COATED FINISH FOR MAXIMUM DURABILITY

RAISED HEAVY-DUTY DECK FOR GOOD GROUND CLEARANCE AND EASY LOADING

SOFT-GRIP HANDLES



TT1



PRECISION STEERING MECHANISM FOR EASY MANOEUVRING



LARGE PUNCTURE-PROOF SOLID RUBBER WHEELS

MANUAL HANDLING PRODUCTS

Product Code	Description	Weight (kg)	External Handle Down Dimensions W x D x H (mm)	External Handle Folded Back Dimensions W x D x H (mm)	Load Capacity
TT1	Turntable Truck™	93	690 x 2540 x 460	690 x 1560 x 770	1000 kg

Note: Weights and dimensions are approximate. External dimensions include handles.

**Safely reduce the manpower required for moving transformers and increase efficiency on site**

Designed and certified to carry transformers, you can now safely reduce manpower and increase efficiency. Save time and money and ensure user safety is always front of mind. Despite its efficient, lightweight design, the **T-Kart™** has a rugged 3 mm steel construction and solid rubber puncture-proof wheels with no detachable parts to ensure the product really is built to last.

**armorgard**  
**t-kart™**



TK1

ERGONOMIC HANDLE FOR LEVERING THE T-KART™ BACKWARDS

HEAVY-DUTY 3 MM STEEL, YET LIGHTWEIGHT TO OPERATE

POWDER-COATED FOR MAXIMUM DURABILITY



SOLID RUBBER PUNCTURE PROOF WHEELS



» WATCH THE T-KART™ IN ACTION

» "I WORK WITH A VARIETY OF TRANSFORMERS. THE CARABINER LATCHING SYSTEM IS PERFECT FOR ANY HEIGHT"

Product Code	Description	Weight (kg)	External Dimensions W x D x H (mm)	Load Capacity
TK1	T-Kart™	34	555 x 400 x 1200	200 kg

Note: Weights and dimensions are approximate. External dimensions include handles.



MANUAL HANDLING PRODUCTS



armorgard  
fittingstor

armorgard  
spoolkart

LOAD SPOOLS EVENLY

**A unique and robust mobile trolley to store, organise and efficiently dispense cable spools**

The **SpoolKart™** is a sturdy yet mobile kart for storing, organising and operating with multiple cable spools. A unique solution to keep your equipment accessible. With three easy loading bars, three anti-tangle dispensers and a lockable built-in storage box, the **SpoolKart™** can take on a load that no other can.

**armorgard**  
**spoolkart™**

BUILT-IN LOCKABLE STORAGE CASE

THREE ANTI-TANGLE CABLE DISPENSERS SUPPLIED AS STANDARD FOR EASE OF USE

SPK2

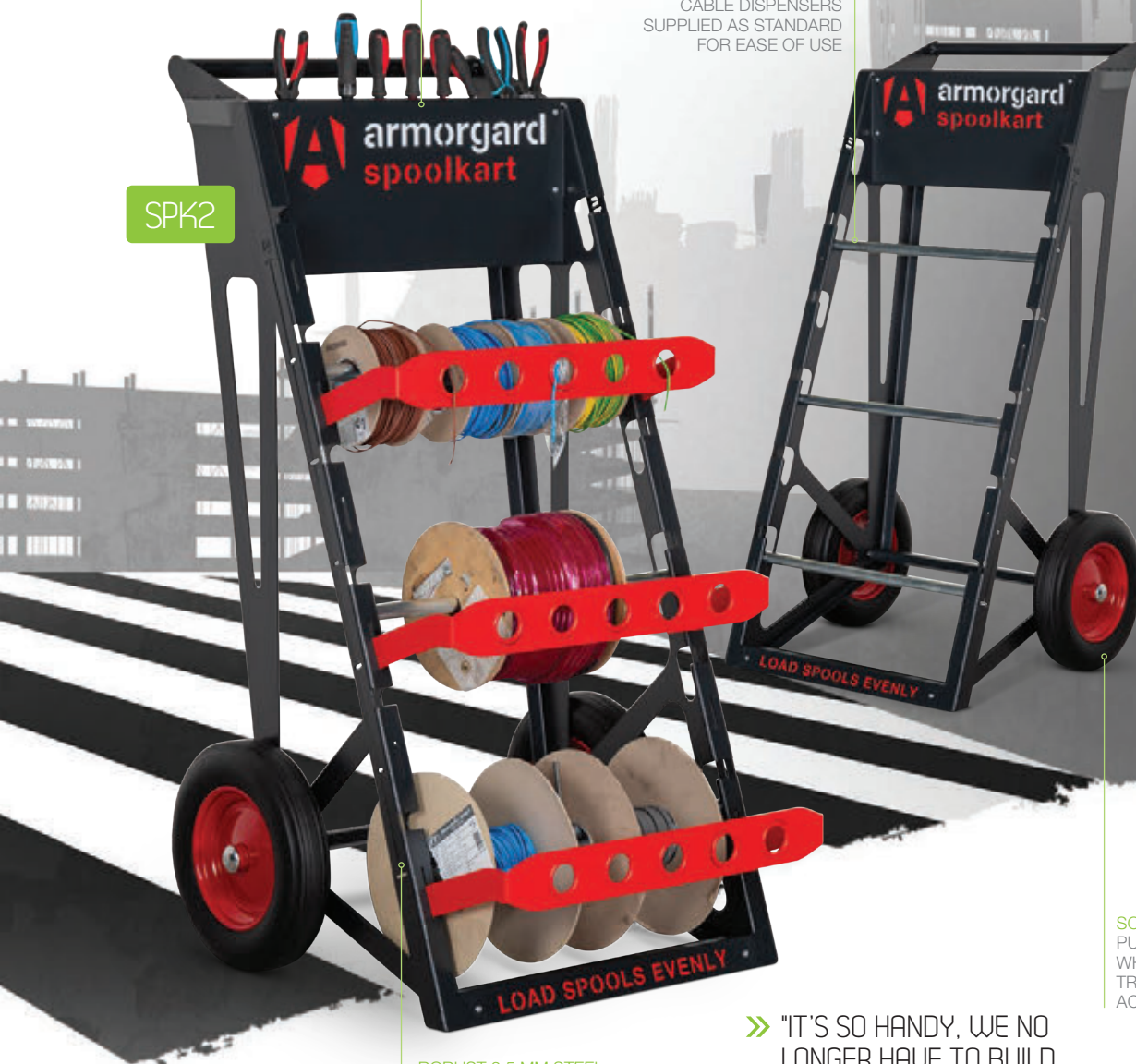

ROBUST 2.5 MM STEEL CONSTRUCTION WITH POWDER COATING FOR MAXIMUM DURABILITY

SOLID RUBBER PUNCTURE-PROOF WHEELS FOR EASY TRANSPORTATION ACROSS ALL TERRAINS

» "IT'S SO HANDY, WE NO LONGER HAVE TO BUILD OUR OWN CABLE MANAGEMENT SOLUTION!"

MANUAL HANDLING PRODUCTS

Product Code	Description	Weight (kg)	External Dimensions W x D x H (mm)	Internal Dimensions W x D x H (mm)
SPK2	SpoolKart™	52	840 x 740 x 1370	470 x 560 x 990

Note: Weights and dimensions are approximate. External dimensions include handles.



## SECTION 05 HAZARDOUS GOODS STORAGE





---

## SECTION 05

### Hazardous goods storage

A guide to storing hazardous substances.....	88
flambank™ .....	90
flamstor cabinet™ .....	94
transbank™ .....	96
transbank chem™ .....	98
chembank™ .....	100
chemcube cabinet™ .....	101
safestor™ .....	102
forma-stor COSHH™ .....	104
flamstor™ .....	108
tuffcage™ .....	110
drumcage™ .....	111
gorilla gas cage™ .....	112
drumbank™ .....	114



# A guide to storing hazardous substances



## Storing fuel and other flammable substances

If you are storing fuels or chemicals, there are laws that you have to comply with. By applying the following five 'VICES' principles you will be well on the way to making sure that you are working safely with flammable substances and chemicals.

We stock a unique range of flammable and chemical storage products to ensure that you can be compliant.

**Ventilation** – Is there plenty of fresh air where flammable substances are being stored and used?

**Ignition** – Have all the obvious ignition sources been removed from the storage and handling areas?

**Containment** – Are your flammable substances kept in suitable containers?

**Exchange** – Can you exchange a flammable substance for a less flammable substance?

**Separation** – Are flammable substances stored and used well away from other process and storage areas?

Flammable liquids can give off large volumes of flammable vapours at room temperature. These vapours, when mixed with air, can ignite, often violently. Spilt flammable liquids can, if not contained, flow a long way to an ignition source and then flashback to the source of the leak. Spills on clothing can represent a serious risk of injury if ignited.

To help control these risks:

- Store flammable liquids in a separate storage area or in a purpose-made bin or cupboard.
- Dispense and use them in a safe place with good ventilation and no ignition source.
- Keep containers closed when not in use.
- Always dispense liquids over a tray and keep a non-flammable spill kit to hand.
- Dispose of contaminated materials safely or call in disposal experts.
- Always keep an adequate number of fire extinguishers to hand.

All storage cabinets must be designed to retain spills (10% volume of the largest vessel normally stored in it or 25% of the total amount stored, whichever is the greater). All flammable liquids must be stored in closed containers and kept in a store that is manufactured from materials that will resist fire for 30 minutes.

## Storing pesticides and other chemicals

**Location** – position your store well away from areas that present a risk of fire.

**Organising** – mark the exterior of the store with general chemical danger warning signs.

**Construction** – provide a store that is resistant to fire for 30 minutes, capable of retaining leakage/spillage adequately ventilated and secure against unauthorised access.

## Transporting pesticides and other chemicals

Pesticides or other chemicals should never be kept in a vehicle for long periods of time – maximum time would be a 24 hour period.

Never carry pesticides or other chemicals in the cab of tractors or any other vehicles. Use a vehicle with a floor to ceiling bulkhead, if possible, between the driver/passenger compartment and the load compartment.

All chemicals must be strapped or secure somehow during transit. It is highly recommended to fit secure containers/cabinets to the vehicle, either inside or securely mounted to the outside or on a trailer. Chemical safes must be sturdy, lockable and fixed down to the vehicle. Ventilation is not necessary.

Pesticides must always be secure against unauthorised access when away from your fixed store. Park your mobile store away from any location where water pollution could occur.

Try to work within sight of your mobile store, especially in public areas. Always ensure the cabinet or vehicle is locked.

The driver must have access in the vehicle to PPE, spillage kit, first aid (including eyewash), and also spare impermeable sealable containers in which to place split containers and any other contaminated material.





### Transporting fuel and other flammable substances

The purpose of the regulations dealing with the carriage of dangerous goods is to protect everyone either directly involved or who might become involved, such as members of the emergency services or public. Regulations place duties on everyone involved in the carriage of dangerous goods to ensure that they know what they have to do to minimise the risk of incidents and guarantee an effective response.

Regulations regarding purchasing, transporting and storing fuel are becoming much more stringent. The following guidelines are for businesses transporting flammables.

#### Filling up containers at petrol stations

All petrol stations are under licence to supply fuel, very similar to alcohol licence. If they are caught breaching these licences, they could lose their right to supply fuel. By law, the only type of can which can be filled up is one approved to UN1203. Most petrol stations have restrictions that prevent more than two cans from being filled in one visit. Typical containers purchased from car accessory shops may not be so approved.

#### Transporting fuel in approved containers

Ensure that you do not carry over the maximum allowed by law without having an ADR licence. This is 333 litres, but HSE will always look at the amount you should have 'reasonably been carrying' if you are involved in an accident. A typical case of transporting fuel would be with 2 or 3 jerry cans. Providing those cans are UN approved, marked UN1203 and labelled with the flammable diamond, the only requirements by law are:

- Driver training in accordance with ADR1.3.
- Carry 2 kg fire extinguisher.
- Stow the jerry cans securely to avoid damage or loss from the vehicle.

The HSE class vans as 'workplaces' during the working day. If a vehicle is involved in an accident, not only do the above regulations come into force but also The Health

and Safety at Work Act. This involves safe storage of the fuel cans and requires that they are stored in secure lockable vented containers.

There is also the risk of spillage of goods, which could lead to fire, explosion or environmental damage. It is highly recommended that an absorbent spill kit is kept onboard every vehicle carrying any form of dangerous liquids.

Fire extinguishers are the subject of conditions from HSE also. They must be easily accessible to the vehicle crew and protected against the effects of the weather.

#### How Armorgard calculate the sump capacity

The sump capacity on all Armorgard products is calculated by the maximum amount of liquid that can be contained within the liquid-tight space in the base of a unit.

#### Disclaimer

The storage of chemicals, flammable substances and gases is the subject of many regulations. Some substances must be stored outside away from buildings. Others can be stored inside but are sometimes subjected to quantity limits. We would always recommend that you should seek the advice of the Health and Safety Inspectorate, your local fire officer, Trading Standards Office or any other qualified body. Armorgard is not an advisor as to where goods shall be stored and can take no liability for any storage situation.

All information can be found at [www.hse.gov.uk](http://www.hse.gov.uk) or by calling HSE's information line.

The ultra-tough,  
lockable vault for storing  
hazardous chemicals  
and flammables

Built to the same high specification as our renowned **TuffBank™** range, the Armorgard **FlamBank™** is specially designed to comply with all COSHH regulations, ensuring that your hazardous substances are securely protected 24/7. Available in 7 sizes, the **FlamBank™** is ideal for use on construction sites, in factories and in vehicles.

# armorgard flambank™



## » OPTIONAL EXTRAS



HEAVY-DUTY CASTORS  
INCREASE MOVABILITY  
ON-SITE



SUITABLE FOR FLAMMABLES  
OR CHEMICALS





TURN OVER FOR MORE INFORMATION ABOUT THE **FLAMBANK™**



HAZARDOUS GOODS STORAGE

FB2

KEYED ALIKE 5-LEVER DEADLOCKS BOTH SIDES WITH HEAVY-DUTY CHUBB-STYLE KEYS

FINISHED IN BRIGHT RED WITH RELEVANT HAZARD WARNING SIGNS FITTED AS STANDARD

STRONG GAS STRUTS AND SAFETY CATCH FITTED AS STANDARD - CONFORMS TO INDUSTRY STANDARDS

SUPPLIED COMPLETE WITH INTERNAL SHELF (ONLY FBC2, FBC4, FBC5 AND FBC8)

FULLY WELDED AND TESTED SUMP BASE TO PREVENT LEAKAGE

FORK SKIDS FOR EASY TRANSPORTATION BY FORKLIFT

HIGH & LOW-LEVEL VENTILATION TO PREVENT BUILD-UP OF FUMES

FLAME ARRESTER GAUZE FITTED ON ALL VENTILATION

ROBUST STEEL PLATE CONSTRUCTION AND POWDER-COATED FOR MAXIMUM DURABILITY



**armorgard**  
flambank™



» "BEST FULL STORAGE CHEST ON THE MARKET"

# armorgard flambank™





TURN BACK FOR MORE INFORMATION ABOUT THE FLAMBANK™

FBC4

FBC5

FBC8

HAZARDOUS GOODS STORAGE



Product Code	Description	Weight (kg)	External Dimensions W x D x H (mm)	Internal Dimensions W x D x H (mm)	Sump Capacity (L)
FB1	Van Box	46	980 x 540 x 475	895 x 470 x 465	60
FB21	Site Box	64	765 x 675 x 670	675 x 605 x 575	40
FB2	Site Box	82	1275 x 665 x 660	1185 x 600 x 575	85
FBC2	Site Chest	107	765 x 675 x 1270	675 x 605 x 1185	50
FBC4	Site Chest	153	1275 x 675 x 1270	1185 x 605 x 1185	85
FBC5	Site Chest	174	1585 x 675 x 1275	1500 x 605 x 1185	110
FBC8	Site Chest	334	2370 x 985 x 1220	2350 x 895 x 1130	250

Note: Weights and dimensions are approximate. External dimensions include handles.

The secure storage cabinet that keeps your hazardous substances safe, organised and accessible

The **Flamstor Cabinet™** is built to the same exacting specification as our popular **TuffStor Cabinet™** but with the addition of specially designed flameproof vents to prevent the build-up of fumes. Complies with all COSHH regulations, ensuring that your hazardous substances are kept safe, accessible and secure.

**armorgard**

# flamstor cabinet™

BUILT TO SPECIFICATION  
30 MINUTES OF FIRE  
RESISTANCE

FINISHED IN BRIGHT RED  
WITH RELEVANT HAZARD  
WARNING SIGNS FITTED  
AS STANDARD

POWDER-COATED  
FOR MAXIMUM DURABILITY

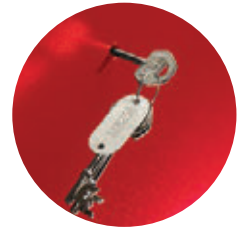

KEYED ALIKE 5-LEVER  
DEADLOCKS BOTH SIDES  
WITH HEAVY-DUTY  
CHUBB-STYLE KEYS

FSC5



FSC4



FULLY WELDED  
AND TESTED SUMP BASE  
TO PREVENT LEAKAGE

FORK SKIDS  
FOR EASY  
TRANSPORTATION

FLAME ARRESTER  
GAUZE FITTED ON  
ALL VENTILATION

FULLY ADJUSTABLE  
SHELVES (ONLY ON  
FSC1, FSC2 AND FSC3)



HIGH & LOW-LEVEL  
VENTILATION TO PREVENT  
BUILD-UP OF FUMES



FSC1



SAFE STORAGE OF ALCOHOL BASED PRODUCTS



FSC2



FSC3

HAZARDOUS GOODS STORAGE



Product Code	Description	Weight (kg)	External Dimensions W x D x H (mm)	Internal Dimensions W x D x H (mm)	Sump Capacity (L)
FSC1	FlamStor Cabinet™	45	500 x 530 x 980	490 x 465 x 895	40
FSC2	FlamStor Cabinet™	74	800 x 585 x 1250	790 x 540 x 1170	115
FSC3	FlamStor Cabinet™	111	1205 x 580 x 1555	1185 x 510 x 1475	130
FSC4	FlamStor Cabinet™	170	1350 x 780 x 1560	1340 x 695 x 1260	190
FSC5	FlamStor Cabinet™	500	2500 x 750 x 2300	2420 x 650 x 2000	300

Note: Weights and dimensions are approximate. External dimensions include handles.

The cost-effective secure container for storing hazardous fuels and chemicals

COSHH regulations require that fuels and chemicals are transported and stored in a secure, lockable container. The Armorgard TransBank™ is purpose-built for exactly that, while protecting them from theft, fire and leakage. Constructed from heavy-duty steel plate, this high-quality, secure container accommodates standard jerry fuel cans and is equally suitable for use as a chemical safe.

**armorgard**  
**transbank™**

SUITABLE FOR CHEMICALS OR FLAMMABLES

FINISHED IN BRIGHT RED WITH RELEVANT HAZARD WARNING SIGNS FITTED AS STANDARD



OVER-CENTRE CATCH WITH PADLOCK FACILITY

ROBUST STEEL PLATE CONSTRUCTION FOR MAXIMUM PROTECTION



FLAME ARRESTER GAUZE FITTED ON ALL BOXES

POWDER-COATED FOR MAXIMUM DURABILITY

INTEGRAL FIXING POINTS ALLOW VAULTS TO BE SECURED TO THE FLOOR OR VEHICLE

FULLY WELDED AND TESTED SUMP BASE TO PREVENT LEAKAGE



For on-site solutions, call our customer experience team on **023 9238 0280** or email **sales@armorgard.co.uk**

TRBS





TRB1



TRB2



TRB3



TRB4



HAZARDOUS GOODS STORAGE



Product Code	Description	Weight (kg)	External Dimensions W x D x H (mm)	Internal Dimensions W x D x H (mm)	Sump Capacity (L)
TRB1	TransBank™	13	430 x 415 x 365	345 x 345 x 335	15
TRB2	TransBank™	20	530 x 485 x 540	445 x 415 x 510	35
TRB3	TransBank™	24	705 x 485 x 540	620 x 415 x 510	70
TRB4	TransBank™	28	880 x 485 x 540	790 x 415 x 510	70
TRB6	TransBank™	38	1195 x 485 x 540	1110 x 415 x 510	90

Note: Weights and dimensions are approximate. External dimensions include handles.

The safe vault for storage and transportation of smaller volumes of chemicals

COSHH regulations require that anyone using chemicals must store them safely in a lockable container. The **TransBank Chem™** has been specially designed to comply with all legislation regarding the storage of chemicals, both in vehicles and in fixed locations. To maximise internal space, vaults are built to accommodate a range of standard sized chemical cans.

**armorgard**

# transbank chem™



TRB4C



VENTILATION TO PREVENT BUILD-UP OF FUMES



OVER-CENTRE CATCH WITH PADLOCK FACILITY



FINISHED IN BRIGHT YELLOW WITH RELEVANT HAZARD WARNING SIGNS



INTEGRAL FIXING POINTS ALLOW VAULTS TO BE SECURED TO THE FLOOR OR VEHICLE

FULLY WELDED AND TESTED SUMP BASE TO PREVENT LEAKAGE

SPECIALLY DESIGNED FOR CHEMICAL STORAGE

POWDER-COATED FOR MAXIMUM DURABILITY



For on-site solutions, call our customer experience team on **023 9238 0280** or email [sales@armorgard.co.uk](mailto:sales@armorgard.co.uk)



TRB1C



TRB2C



TRB4C

HAZARDOUS GOODS STORAGE



Product Code	Description	Weight (kg)	External Dimensions W x D x H (mm)	Internal Dimensions W x D x H (mm)	Sump Capacity (L)
TRB1C	TransBank Chem™	13	430 x 415 x 365	345 x 345 x 335	15
TRB2C	TransBank Chem™	20	530 x 485 x 540	445 x 415 x 510	35
TRB4C	TransBank Chem™	28	880 x 485 x 540	790 x 415 x 510	70

Note: Weights and dimensions are approximate. External dimensions include handles.

The high security lockable vault for the safe storage of chemicals

Purpose-built for the safe storage of chemical substances, the ChemBank™ conforms to all relevant COSHH requirements. The tough welded construction delivers maximum protection from thieves and the elements, while its distinctive bright yellow colour and signage make it easy to distinguish between fuel and chemical stores – a particular benefit for sites with multi-national workforces.

**armorgard**  
**chembank™**



CBC4

POWDER-COATED FOR MAXIMUM DURABILITY. CONSTRUCTED USING 2 & 3 MM STEEL

CBC4 MODEL SUPPLIED WITH 1 INTERNAL SHELF



ROBUST AND SECURE KEYED ALIKE 5 LEVER DEADLOCKS



STRONG GAS STRUTS AND SAFETY CATCH FITTED AS STANDARD

HIGH & LOW-LEVEL VENTILATION TO PREVENT BUILD-UP OF FUMES

CB2

FORKLIFT SKIDS TO ALLOW FOR EASY TRANSPORTATION VIA FORKLIFT

FINISHED IN BRIGHT YELLOW WITH RELEVANT HAZARD WARNING SIGNS



For on-site solutions, call our customer experience team on **023 9238 0280** or email **sales@armorgard.co.uk**

Product Code	Description	Weight (kg)	External Dimensions W x D x H (mm)	Internal Dimensions W x D x H (mm)	Sump Capacity (L)
CB2	Site Box	86	1275 x 665 x 660	1185 x 600 x 575	85
CBC4	Site Chest	150	1275 x 675 x 1270	1185 x 605 x 1185	85

Note: Weights and dimensions are approximate. External dimensions include handles.

The leak-proof, lockable cabinet that keeps your chemicals safe and accessible

Available in three sizes, the Armorgard Chemcube Cabinet™ is purpose-built to keep your chemicals safe and accessible. For extra convenience, the smallest size is also wall-mountable.



# chemcube cabinet™

- VENTILATION TO PREVENT BUILD-UP OF FUMES
- RELEVANT HAZARD WARNING SIGNAGE ATTACHED
- COMES COMPLETE WITH TWO HEAVY-DUTY SHELVES
- NOT SUITABLE FOR FLAMMABLE MATERIALS
- LOCKABLE DOORS TO PREVENT UNAUTHORISED ACCESS
- DURABLE UV RESISTANT PLASTIC PREVENTING CORROSION
- 105 L SUMP CAPACITY TO CONTAIN ACCIDENTAL SPILLAGES



HAZARDOUS GOODS STORAGE



Product Code	Description	Weight (kg)	External Dimensions W x D x H (mm)	Internal Dimensions W x D x H (mm)	Sump Capacity (L)
CCC1	ChemCube Cabinet™	15	575 x 440 x 910	515 x 385 x 900	16
CCC2	ChemCube Cabinet™	27	695 x 515 x 1310	660 x 450 x 1260	60
CCC3	ChemCube Cabinet™	47	1220 x 520 x 1310	1050 x 450 x 1050	125

Note: Weights and dimensions are approximate. External dimensions include handles.

The medium-duty hazardous substance cabinet that complies with all COSHH regulations

The **SafeStor™** is purpose-built for the indoor safe storage of flammables and chemicals, including paint and other hazardous substances. Fully compliant with all legislation relating to the Control of Substances Hazardous to Health (COSHH), this range of cabinets features a liquid-tight sump to contain spillages, as well as galvanised shelves for maximum durability.

**armorgard**  
**safestor™**



For on-site solutions, call our customer experience team on **023 9238 0280** or email **sales@armorgard.co.uk**



HAZARDOUS GOODS STORAGE



Product Code	Description	Weight (kg)	External Dimensions W x D x H (mm)	Internal Dimensions W x D x H (mm)	Sump Capacity (L)
HFC1	SafeStor™	21	900 x 465 x 700	890 x 395 x 640	30
HFC2	SafeStor™	13	350 x 315 x 700	335 x 245 x 640	7
HFC3	SafeStor™	28	900 x 465 x 900	890 x 395 x 840	30
HFC4	SafeStor™	31	450 x 465 x 905	440 x 395 x 840	17
HFC5	SafeStor™	41	900 x 465 x 1200	890 x 395 x 1140	30
HFC6	SafeStor™	68	1200 x 465 x 1800	1190 x 395 x 1740	45
HFC7	SafeStor™	55	900 x 465 x 1800	890 x 395 x 1740	35
HMC1	SafeStor Mobile™	26	900 x 465 x 810	890 x 395 x 640	30
HMC2	SafeStor Mobile™	33	900 x 465 x 1010	890 x 395 x 840	30
HCS1	SafeStor™ Stand	10	460 x 460 x 500	N/A	N/A
HCS2	SafeStor™ Stand	10	900 x 460 x 500	N/A	N/A
HCS3	SafeStor™ Stand	5	350 x 300 x 500	N/A	N/A

Note: Weights and dimensions are approximate. External dimensions include handles.





Our new COSHH compliant, quick-assembly, modular storage units for the safe storage of hazardous substances

Forma-Stor COSHH™ is our innovative modular solution for on-site secure storage. Flat-packed Forma-Stor COSHH™ units can be constructed in around 10 minutes with very few tools and can be moved easily using built-in forklift pockets or lifting eyes. Galvanised panels fasten neatly together to provide a robust store that can be configured in numerous sizes, starting from just 1 m x 2 m. Several HSE features have been carefully designed to enable contractors to meet COSHH regulations on-site.



# forma-stor COSHH™



CRANE LIFTING EYES SUPPLIED AS STANDARD FOR EASY TRANSPORTATION



FULLY GALVANISED AND POWDER-COATED FOR MAXIMUM DURABILITY



FR300-C

CAN BE DELIVERED PRE-ERECTED AT AN ADDITIONAL COST

MEETS RELEVANT LEGISLATION FOR STORING FUEL AND CHEMICALS

AVAILABLE IN 4 STANDARD SIZES

HEAVY-DUTY RAISED OPEN STEEL FLOOR – ALLOWS SPILLAGES TO DRAIN DIRECTLY INTO SUMP

FORKLIFT POCKETS FOR EASY MANOEUVRING BY FORKLIFT

RELEVANT HAZARD WARNING SIGNAGE

HEAVY-DUTY DOORS WITH 5-LEVER DEADLOCKS AND JEMMY-PROOF JOINS

HAZARDOUS GOODS STORAGE



For on-site solutions, call our customer experience team on **023 9238 0280** or email **sales@armorgard.co.uk**

» SECURE, FIRE-RESISTANT,  
VENTILATED AND  
LEAK-PROOF STORAGE

 **armorgard**

# forma-stor COSH<sup>TM</sup>



»  
FORMA-STOR COSH<sup>TM</sup> IS  
DELIVERED FLAT-PACKED  
FOR EASY TRANSPORTATION



FR100-C



FR300-C



HAZARDOUS GOODS STORAGE

» FORMA-STOR™ ACCESSORIES



BLOKKABAR



CERTIFIED SHELVES

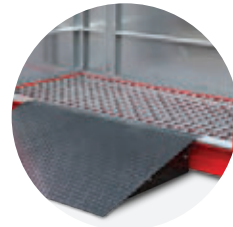

HEAVY-DUTY RAMP

Product Code	Description	Weight (kg)	External Dimensions (Including Protrusions) W x D x H (mm)	Internal Dimensions W x D x H (mm)	Sump Capacity (L)
FR100-C	Forma-Stor COSHH™	277	2075 x 1120 x 2255	1920 x 970 x 1960	220
FR200-C	Forma-Stor COSHH™	415	2075 x 2075 x 2255	1920 x 1920 x 1960	440
FR300-C	Forma-Stor COSHH™	553	2990 x 2075 x 2255	2840 x 1920 x 1960	680
FR400-C	Forma-Stor COSHH™	663	3995 x 2075 x 2255	3840 x 1920 x 1960	960
FRS2M	Forma-Stor™ Shelf	20	1970 x 520 x 30	N/A	N/A
FRBL2	BlokkaBar	23	1960 x 170 x 110	N/A	N/A
FRR4	Forma-Stor™ Ramp	37	1185 x 750 x 100-195	N/A	N/A

Note: Weights and dimensions are approximate. External dimensions include handles.

The ultra-secure walk-in hazardous storage unit for fixed installation

The Armorgard FlamStor™ is the perfect solution for storing larger quantities of chemicals or flammable substances. Manufactured to an exacting standard throughout, this heavy-duty walk-in storage unit features a high-security anti-tamper door, fixed internal shelving and an innovative open steel floor, which allows spillages to drain directly into the sump. The FlamStor™ can also be customised to suit your exact requirements.

armorgard  
flamstor™



For on-site solutions, call our customer experience team on **023 9238 0280** or email [sales@armorgard.co.uk](mailto:sales@armorgard.co.uk)



FS1.2



FS1.8



FS2.0



FS3.0

HAZARDOUS GOODS STORAGE

Product Code	Description	Weight (kg)	External Dimensions W x D x H (mm)	Internal Dimensions W x D x H (mm)	Sump Capacity (L)
FS1.2	FlamStor™	280	1210 x 1270 x 2190	1125 x 1110 x 1980	120
FS1.8	FlamStor™	370	1210 x 1860 x 2190	1085 x 1710 x 1980	195
FS2.0	FlamStor™	570	2000 x 2060 x 2175	1900 x 1912 x 1977	400
FS3.0	FlamStor™	760	2000 x 3066 x 2175	1900 x 2912 x 1977	600
FS4.0	FlamStor™	940	2000 x 4066 x 2175	1900 x 3912 x 1977	800
FS6.0	FlamStor™	1300	2000 x 6066 x 2175	1900 x 5066 x 1977	1000

Note: Weights and dimensions are approximate. External dimensions include handles. Design may vary from the images displayed.

The one-piece folding security cage for storing your gas cylinders and costly equipment

The ingeniously designed TuffCage™ is the answer to a wide range of on-site security needs. Constructed from galvanised heavy-duty steel, this robust high-security cage is suitable for storing gas cylinders as well as tools and equipment.

# armorgard tuffcage™



SUITABLE FOR SECURING TOOLS AND EQUIPMENT AS WELL AS GAS CYLINDERS

RELEVANT HAZARDOUS WARNING SIGNAGE

QUICK AND EASY TO ERECT AND DISMANTLE

EASILY STACKED WHEN FOLDED DOWN, SAVING ON SPACE

FORKLIFT SKIDS FOR EASY TRANSPORTATION



TC1.2



ONE-PIECE CONSTRUCTION WITH NO REMOVABLE PARTS



2 SECURE PADLOCK POINTS



GALVANISED FOR MAXIMUM DURABILITY IN ALL WEATHER



FOLDS DOWN TO A HEIGHT OF JUST 180 MM AND CAN BE STACKED UP

Product Code	Description	Weight (kg)	External Dimensions W x D x H (mm)	Internal Dimensions W x D x H (mm)	No. Standard Size Gas Bottles
TC1.2	TuffCage™	133	1300 x 1240 x 1800	1220 x 1090 x 1760	47/19

Note: Weights and dimensions are approximate. External dimensions include handles.

A storage unit suitable for storing many types of hazardous substances

DrumCage™ is the first choice for the safe storage of hazardous substances. With a unique COSHH compliant design, DrumCage™ is one of the few storage units on the market that is suitable for storing many types of hazardous substances, including gas and liquids.

**armorgard**

# drumcage™

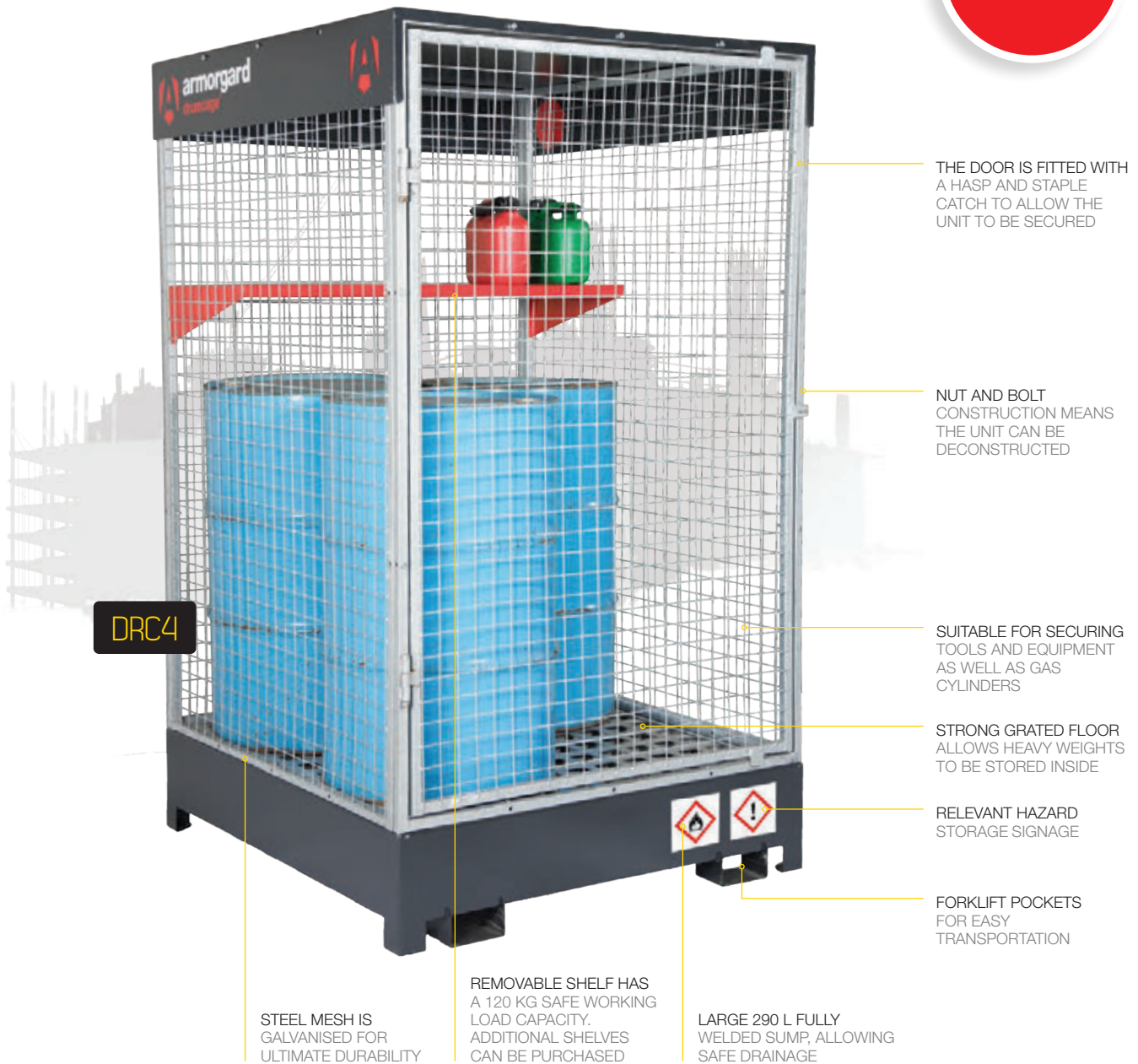

THE DOOR IS FITTED WITH A HASP AND STAPLE CATCH TO ALLOW THE UNIT TO BE SECURED

NUT AND BOLT CONSTRUCTION MEANS THE UNIT CAN BE DECONSTRUCTED

SUITABLE FOR SECURING TOOLS AND EQUIPMENT AS WELL AS GAS CYLINDERS

STRONG GRATED FLOOR ALLOWS HEAVY WEIGHTS TO BE STORED INSIDE

RELEVANT HAZARD STORAGE SIGNAGE

FORKLIFT POCKETS FOR EASY TRANSPORTATION

**DRC4**

STEEL MESH IS GALVANISED FOR ULTIMATE DURABILITY

REMOVABLE SHELF HAS A 120 KG SAFE WORKING LOAD CAPACITY. ADDITIONAL SHELVES CAN BE PURCHASED

LARGE 290 L FULLY WELDED SUMP, ALLOWING SAFE DRAINAGE

HAZARDOUS GOODS STORAGE

Product Code	Description	Weight (kg)	External Dimensions W x D x H (mm)	Internal Dimensions W x D x H (mm)	Sump Capacity (L)
DRC4	DrumCage™	215	1215 x 1265 x 2100	1150 x 1200 x 1800	290

Note: Weights and dimensions are approximate. External dimensions include handles.

The unique galvanised security cage specially designed for storing gas cylinders

Robustly constructed using 25 mm box sections and 3 mm wire mesh, the **Gorilla Gas Cage™** features a unique modular bolt-together design using individual galvanised panels, making it quick and easy to erect and dismantle. Suitable for use on site or in the storage yard, it comes complete and ready to erect with all fixings and flat packs when not in use.

**armorgard**

# gorilla gas cage™



AVAILABLE IN 16 SIZES

SUPPLIED COMPLETE WITH ALL FIXINGS

ROBUST CONSTRUCTION USING 25 MM BOX SECTIONS AND 3 MM WIRE MESH

RELEVANT HAZARD WARNING SIGNAGE ATTACHED

QUICKLY DISMANTLED WHEN NOT IN USE AND STORED AS INDIVIDUAL PANELS

PADLOCK POINT TO SECURE UNIT FROM THEFT

GALVANISED FINISH - RESISTS ALL WEATHER CONDITIONS FOR MAXIMUM DURABILITY

FACILITY TO FIX TO GROUND FOR ADDED SECURITY AND STABILITY

CUSTOMISABLE TO SUIT ANY REQUIREMENT



For on-site solutions, call our customer experience team on **023 9238 0280** or email **sales@armorgard.co.uk**





Product Code	Description	Weight (kg)	External Dimensions W x D x H (mm)	Internal Dimensions W x D x H (mm)
GGC1	Gas Bottle Cage	40	1012 x 563 x 931	950 x 500 x 900
GGC2	Gas Bottle Cage	62	912 x 576 x 1831	850 x 500 x 1800
GGC3	Gas Bottle Cage	60	912 x 566 x 1831	850 x 500 x 1800
GGC4	Gas Bottle Cage	68	1212 x 1266 x 1231	1150 x 1200 x 1200
GGC5	Gas Bottle Cage	67	912 x 966 x 1831	850 x 900 x 1800
GGC6	Gas Bottle Cage	87	1212 x 1266 x 1831	1150 x 1200 x 1800
GGC7	Gas Bottle Cage	98	1812 x 966 x 1831	1750 x 900 x 1800
GGC8	Gas Bottle Cage	108	1812 x 1266 x 1831	1750 x 1200 x 1800
GGC9	Gas Bottle Cage	135	1812 x 1866 x 1831	1750 x 1800 x 1800
GGC10	Gas Bottle Cage	165	2412 x 1866 x 1831	2350 x 1800 x 1800
GGC11	Gas Bottle Cage	188	2712 x 1866 x 1831	2650 x 1800 x 1800
GGC12	Gas Bottle Cage	182	2412 x 2466 x 1831	2350 x 2400 x 1800
GGC13	Gas Bottle Cage	226	2412 x 3666 x 1831	2350 x 3600 x 1800
GGC14	Gas Bottle Cage	270	2412 x 4866 x 1831	2350 x 4800 x 1800
GGC15	Gas Bottle Cage	314	2412 x 6066 x 1831	2350 x 6000 x 1800
GGC16	Gas Bottle Cage	279	3612 x 3666 x 1831	3555 x 3600 x 1800
GGC17	Gas Bottle Cage	205	3662 x 1810 x 1831	3600 x 1750 x 1800

Note: Weights and dimensions are approximate. External dimensions include handles.

The enclosed store and spill pallet for the safe storage of oil drums

The Armorgard DrumBank™ is specially designed for the safe storage and dispensing of oil drums. Highly robust, the enclosed version is fitted with a heavy-duty door with a 5-lever deadlock to protect your high-value fuel and oil from theft and fire. This innovative purpose-built product is fully compliant with all COSHH regulations for the safe storage of 205-litre drums.

# armorgard drumbank™



ENCLOSED UNIT FOR THE SAFE STORAGE OF IBC CONTAINERS OR OIL DRUMS

SUITABLE FOR STORING CHEMICALS OR FUELS

DBIBC1

FULLY WELDED 1100 L SUMP WITH RAISED AND REMOVABLE STEEL GRID FLOORING

FORK SKIDS FOR EASY LIFTING





TURN OVER FOR MORE INFORMATION ABOUT THE DRUMBANK™



DB2S

UP TO 2 X 205 L DRUMS CAN BE SECURED INSIDE

FULLY WELDED 240 L SUMP WITH RAISED AND REMOVABLE STEEL GRID FLOORING

WELDED SHELF FOR STORING SMALLER FUEL CANS

SPACE ABOVE THE DRUMS TO ENABLE A PUMP TO BE ATTACHED WITHOUT NEEDING TO REMOVE DRUM FROM UNIT

UP TO 4 X 205 L DRUMS CAN BE SECURED INSIDE



DB4S

FULLY WELDED 370 L SUMP WITH RAISED AND REMOVABLE STEEL GRID FLOORING

HAZARDOUS GOODS STORAGE

The enclosed store and spill pallet for the safe storage of oil drums

The Armorgard DrumBank™ is specially designed for the safe storage and dispensing of oil drums. Highly robust, the enclosed version is fitted with a heavy-duty door with a 5-lever deadlock to protect your high-value fuel and oil from theft and fire. This innovative purpose-built product is fully compliant with all COSHH regulations for the safe storage of 205-litre drums.

# armorgard drumbank™

STRONG GAS STRUTS  
FITTED AS STANDARD  
- CONFORMS TO  
INDUSTRY STANDARDS



HEAVY-DUTY DOOR  
WITH ONE 5-LEVER  
DEADLOCK

DB4

FORK SKIDS  
FOR EASY LIFTING

RAISED REMOVABLE  
OPEN FLOOR

MEETS RELEVANT  
REGULATION FOR  
STORING FUEL  
OR CHEMICALS

POWDER-COATED  
FOR MAXIMUM DURABILITY



For on-site solutions, call our customer experience team on **023 9238 0280** or email **sales@armorgard.co.uk**



TURN BACK FOR MORE INFORMATION ABOUT THE DRUMBANK™



HAZARDOUS GOODS STORAGE



Product Code	Description	Weight (kg)	External Dimensions W x D x H (mm)	Internal Dimensions W x D x H (mm)	Sump Capacity (L)
DB2	2 Drum DrumBank™	178	1385 x 1075 x 1345	1290 x 860 x 1100	295
DB4	4 Drum DrumBank™	231	1420 x 1345 x 1290	1300 x 1225 x 1050	485
DBP2	DrumBank™ Pallet	20	1310 x 750 x 435	N/A	250
DBP4	DrumBank™ Pallet	32	1290 x 1380 x 280	N/A	405
DB2S	DrumBank™	255	1405 x 925 x 2195	1305 x 775 x 1810	240
DB4S	DrumBank™	345	1405 x 1420 x 2195	1305 x 1280 x 1810	370
DBIBC1	DrumBank™	390	1500 x 1530 x 2210	1380 x 1380 x 1645	1100

Note: Weights and dimensions are approximate. External dimensions include handles.



## SECTION 06

### Replacement keys and parts



#### Lost keys?

We hold in-stock replacement keys for our products for up to 5 years after purchase, so we can get you quick access should you lose your keys. Each product carries a unique serial number, and this enables us to locate your exact key and despatch immediately.



#### Spare parts

To complement our extensive range, we also hold in stock a vast supply of spare parts for our products. This enables us to deliver quickly and fulfil any replacement requirements.



#### Castors

**Added flexibility for many of our products.**

High-quality, heavy-duty castor sets with a unique quick-fit system. Replacements available for simply bolting on yourself, using the pre-drilled holes.





## Keys

Product Code	Description
KEY	Replacement Deadlock Key
KEY3	Replacement Deadlock Key - Set of 3



## Castors

Product Code	Description	Contains	Loading Capacity
CAS160-KS-FX-SB-CP	6" Castors (Supply Only) c/w Fixing Kit	2 x Fixed, 2 x Swivel Braked Castors	135 kg
CAS160HD-KS-SW-SB-CP	6" Heavy-Duty Castors (Supply Only) c/w Fixing Kit	2 x Swivel, 2 x Swivel Braked Castors	350 kg
CAS-DLF	Castor Direction Lock Adaptors		
CAS200-KS-SW-SB-BT	Castors for LA1500	2 x Swivel, 2 x Swivel Braked Castors	500 kg

## Shelves

Product Code	Description
SHE-C1	Shelf c/w Brackets for FSC1 and TSC1
SHE-C2	Shelf c/w Brackets for FSC2, TSC2 and FC2
SHE-C3	Shelf c/w Brackets for FSC3, TSC3 and FC3
SHE-OX4	Shelf for OX4
SHE-CH2	2' Shelf for FBC2
SHE-CH4	4' Shelf for FBC4 and CBC4
SHE-CH5	5' Shelf for FBC5
FRS2	2 m Shelf for Forma-Stor™ Tool and COSHH
SHE-4	Shelf for TB2, TB12, TB3 & TBC4
SHE-D4	Shelf for TBC4
SHE-D5	Shelf for TBC5
TBS4P	PowerShelf for TB2, TB12, TB3 & TBC4
SHE-DP4-110	PowerShelf for TBC4
SHE-DP5-110	PowerShelf for TBC5



## Locks

Product Code	Description
LOCK-DL2	Pair 5 Lever Deadlocks
LOCK-DL1	Single 5 Lever Deadlock



## Gas struts and lid stay

Product Code	Description
G300	300 N Gas Strut
G300S	300 N Short Gas Strut
G450	450 N Gas Strut
G1000	1000 N Gas Strut
G1200	1200 N Gas Strut
STAY1	Lid Support Stay for Boxes
STAY2	Lid Support Stay for Chests
SLM-200	SlamStop Lid Stay Short
SLM-300	SlamStop Lid Stay Long



## fittingstor™ bins

Product Code	Description	Available For
FCB	Storage Bins for FittingStor™	FC2, FC3, FC4, FC5, FC6



Do you need any other spare parts? We can help! Talk to our team to find out more. Call us on **023 9238 0280** or email **sales@armorgard.co.uk**



Find us on social media:



**UK Head Office**

Unit 14-16 Standard Way, Fareham Industrial Park, Fareham, Hampshire PO16 8XB

Call **+44 (0)23 9238 0280** Email **sales@armorgard.co.uk** **www.armorgard.co.uk**



**France Office**

Call **+ 33 (0)4 81 16 06 69**

Email **commercial@armorgard.fr**

**www.armorgard.fr**



**Australia Office**

Call **+61 (0)1300 131 751**

Email **sales@armorgard.com.au**

**www.armorgard.com.au**



**New Zealand Office**

Call **+64 (0)4 280 6440**

Email **sales@armorgard.co.nz**

**www.armorgard.co.nz**